



UNIVERSITY OF CAPE COAST  
**RESEARCH  
REPORT**  
2012-2016









# Contents

Foreword	6
Message from DRIC Director	7
Brief History of UCC	8
Vision and Mission of UCC	10
Research Activities in the College	12
College of Agriculture and Natural Sciences (CANS)	12
School of Agriculture Research Projects	14
School of Biological Sciences Research Projects	21
School of Physical Sciences Research Projects	31
CANS Description of Funded Research	36
College of Education Studies (CES)	78
CES Description of Funded Research	84
College of Health and Allied Sciences (CoHAS)	90
CoHAS Description of Funded Research	98
College of Humanities and Legal Studies	122
CHLS Description of Funded Research and Creative Projects	142
Centre for International Education	162
UCC Maiden Call for Research Support Grants	166
Awards and Achievements	170
Innovation and Consultancy	180
DRIC Management Committee	184
Acknowledgements	185





Copyright © 2017 by UCC. All rights reserved. No part of this publication should be reproduced, stored in a database or retrieval system, or transmitted by any form or means, without the prior written permission of the publisher.

Published by Axxiom Communications  
[www.axxiomglobal.com](http://www.axxiomglobal.com)

# LIST OF ABBREVIATIONS

<b>AFUF</b>	Academic Facility User Fee	<b>HBB</b>	Helping Babies Breathe
<b>APSP</b>	Agriculture Policy Support Project	<b>ICDD</b>	International Centre for Development and Decent Work
<b>BNARI</b>	Biotechnology and Nuclear Agriculture Research Institute	<b>ICTP</b>	International Centre for Theoretical Physics
<b>CANS</b>	College of Agriculture and Natural Sciences	<b>IEPA</b>	Institute for Educational Planning and Administration
<b>CCM</b>	Centre for Coastal Management	<b>IPBES</b>	Intergovernmental Science-Policy Platform on Biodiversity and Ecosystem Services
<b>CCTH</b>	Cape Coast Teaching Hospital	<b>IPPS</b>	International Programme for Physical Sciences
<b>CERED</b>	Centre for Educational Research, Evaluation and Development	<b>ISP</b>	International Science Programme
<b>CES</b>	College of Education Studies	<b>ICA</b>	Japan International Cooperation Agency
<b>CHASS</b>	Conference of Heads of Assisted Secondary Schools	<b>KAC</b>	Kwadaso Agricultural College
<b>CoHAS</b>	College of Health and Allied Sciences	<b>KNUST</b>	Kwame Nkrumah University of Science and Technology
<b>COTVET/SDF</b>	Council for Technical and Vocational Education and Training/ Skills Development Fund	<b>LAFOC</b>	Laser and Fibre Optics Centre
<b>CSIR-CRI</b>	Council for Scientific and Industrial Research - Crops Research Institute	<b>MMDAs</b>	Metropolitan, Municipal and District Assemblies
<b>CSIR-PGRRI</b>	Council for Scientific and Industrial Research - Plant Genetic Resources Research Institute	<b>MoE</b>	Ministry of Education
<b>CTA</b>	Technical Centre for Agricultural and Rural Cooperation	<b>MOFA</b>	Ministry of Food and Agriculture
<b>CWC</b>	Child Welfare Clinic	<b>NATBA</b>	National Beekeepers Association
<b>DAAD</b>	German Academic Exchange Service	<b>Nuffic</b>	Netherlands Fellowship Programme
<b>DANIDA</b>	Denmark International Development Agency	<b>RAFIP</b>	Rural and Agricultural Finance Programme
<b>DFID</b>	Department for International Development	<b>JSHARE</b>	Sharing Capacity to Build Capacity for Quality Training in Agriculture in African University
<b>DRIC</b>	Directorate of Research, Innovation and Consultancy	<b>SoNM</b>	School of Nursing and Midwifery
<b>ECEB</b>	Essential Care for Every Baby	<b>UCC</b>	University of Cape Coast
<b>FAO</b>	The United Nations Food and Agriculture Organization	<b>UG</b>	University of Ghana
<b>FBOs</b>	Farmer Based Organisations	<b>UNDP</b>	United Nations Development Programme
<b>FtF</b>	Feed the Future	<b>UNEP</b>	United Nations Environment Program
<b>GAEC</b>	Ghana Atomic Energy Commission	<b>UNICEF</b>	United Nations International Children's Emergency Fund
<b>GEF</b>	Global Environmental Facility	<b>UoHAS</b>	University of Health and Allied Sciences
		<b>USAID</b>	United States Agency for International Development
		<b>USDA</b>	United States Department of Agriculture
		<b>WASH</b>	Water, Sanitation and Hygiene





# FOREWORD

**Prof. Joseph Gharthey Ampiah**  
Vice-Chancellor

The University of Cape Coast (UCC), since its establishment in 1962, has conscientiously committed to its mandate of ensuring excellence in a wide array of academic disciplines and professional domains. Delivering on this mandate, has in part, led to the production of internationally competitive and rewarding research outputs and community services over the years. These achievements give expression to the quality of human capacity and intellectual endowment of the University. Both of these defining characteristics of UCC need to be showcased within and outside the country to sustain a cycle of continuous knowledge generation and transformation of lives. Publicizing our contribution to knowledge through research, will substantially improve the University's visibility, which is critical for attracting financial and human resources to our great institution through higher regional and world rankings.

Taking cognizance of the importance of dissemination of evidence-based research for sustainable development as well as its implications for the University's competitive image, the University, through the Directorate of Research, Innovation

and Consultancy (DRIC) commissioned a team of faculty members to compile this research output of the University over the last five years for the collective benefit of society. The report comprises research output from the Colleges and other research Directorates and Centres of the University. It covers a plethora of research areas in the Arts, Education, Social Sciences, Medical Sciences and the Natural Sciences undertaken by individuals, departments, and faculties, either independently or in collaboration with other institutions, government and non-governmental organisations, donor agencies and development partners.

In the globalized world of today, it is imperative to link knowledge and action for sustainable development. We believe that for this linkage to blossom we, first of all, need to collaborate across academic disciplines, geopolitical regions and spatial scales (local, national, regional, global) to generate robust knowledge that is responsive to an increasingly complex and dynamic world. Second, we need to document and cumulate existing knowledge in order to inform and sharpen our medium to long-term research agenda. Third, it is necessary

to forge academia-industry partnerships that have the capacity to provide leading edge technological solutions to the myriad of challenges we face as a nation. I, therefore, take this opportunity to inform the public that, the University of Cape Coast remains committed to research and is open for collaborative research efforts with other research-oriented individuals, academic institutions of higher learning, industry and development partners for cutting-edge research activities that will advance the frontiers of knowledge for sustainable development. On behalf of the University Council, I commend the dedicated researchers and research administrators whose research endeavours and administrative support respectively, have made the publication of this maiden edition of the research report possible. It is my fervent hope that they will commit even greater efforts to making the subsequent editions of the report more informative and educative for the benefit of both the academic and non-academic communities and ultimately, the enhancement of the University's visibility and image as a citadel of academic excellence.

## MESSAGE FROM THE DIRECTOR DIRECTORATE OF RESEARCH, INNOVATION AND CONSULTANCY

### Prof. Samuel Kobina Annim

Director - DRIC

The re-positioning agenda of the University of Cape Coast (UCC), which was spurred by changing trends and patterns of multi-faceted and interlinked socio-economic, political and cultural issues, is anchored by a new era of active engagement in quality research. Among the numerous interventions that centre-stages research at UCC is the redefinition of the mandate of the then Consultancy Unit to include oversight responsibilities of research and innovation. This led to the establishment of the Directorate of Research, Innovation and Consultancy (DRIC) in 2013. The expected outcome indicators of DRIC's mandate in superintending activities related to research, innovation and consultancy include, but not limited to, increased number of national and international research grant contracts and consultancy, improved researcher productivity, improved ranking of UCC among Universities in Ghana, Africa and beyond, and increased number of patents. These outcomes are expected to culminate in the transformation of lives, thereby making UCC more visible in serving as an indispensable hub for hosting and producing high quality researchers as well as engaging in cutting-edge research.

Since the dawn of the new research era in UCC, faculty members have been resourced in diverse ways.

The services and resources offered include: organising sensitisation workshops on issues related to publication and visibility; offering mentorship workshops on article writing; revamping the provision of research support grants; streamlining and expanding the provision of travel grants for conference attendance; and publicising calls for external research grants, contracts and consultancy. The University Management, on the other hand, has witnessed provision of new research services in the areas of documenting research output and productivity; ranking Departments, Faculties/Schools and Colleges based on aggregate number of publications and citations of faculty members; developing policies specifically Research Policy and the Intellectual Property Policy for UCC; and providing advise on all matters related to research, innovation and consultancy. Notable, of the advice are matters related to improved quality of research and visibility.

Following from the four years of intensive engagements aimed at strengthening research output in UCC, the time has come to showcase to the global community the rich and diverse research capability, capacity and track record of faculty members in UCC. This maiden research report tends to serve this purpose. With academic units comprising five colleges, 15 faculties/schools and more than 80 Departments/Centres/



Institutes/Directorates/Units, research output is indeed diverse. This corroborates the scope of the University's research theme - Health, Education and Environmental Sustainability for National Development In Changing Global Contexts - for the period 2013 - 2017. Guided by the theme and internal support received over the period as well as scope, nature and regularity of external calls for research grants, contracts and consultancy, faculty members in the last five years have executed various research assignments worth showcasing to the global community. This publication is intended to show appreciation to funders and collaborators of research conducted in and by faculty members of UCC, industry partners who have utilised capacity endowed in the University and also, to sustain and attract new collaborations, funding and industry engagement.

The DRIC with support from University Management will ensure sustenance of the interventions and as well, introduce new tools to improve research capacity in UCC. Among the new research tools to be introduced in the 2018 calendar year are Elsevier's solutions (ScienceDirect, Scopus and SciVal) and the establishment of an Industry and Innovation Unit.



# **BRIEF HISTORY, VISION AND MISSION OF UCC**

---

*The University of Cape Coast is one of the rare sea front universities in the world.*

---

## ***Brief History***

**T**he University of Cape Coast was established in October, 1962 as a result of a recommendation of an international commission appointed by the Ghana Government in December, 1960 to advise on the future of University education in the country and the possibility of establishing a third university at Cape Coast. The College was formally inaugurated on 15th December, 1962.

On 1st October, 1971, the College attained the status of a full and independent University, with the authority to confer its own degrees, diplomas and certificates by an Act of Parliament - The University of Cape Coast Act, 1971 [Act 390] and subsequently the University

of Cape Coast Law, 1992 [PNDC Law 278]. The University was established out of a dire need for highly qualified and skilled labour in education to provide leadership and enlightenment. Its original mandate was therefore to train graduate professional teachers for Ghana's second cycle institutions and the Ministry of Education, in order to meet the labour needs of the country's accelerated education programme at the time. Today, with the expansion of some of its faculties and the diversification of programmes, the University has the capacity to meet the labour needs of other ministries and industries in the country, besides that of the Ministry of Education.



The University started with two departments, namely Arts and Science. These departments developed into faculties in 1963. In order to achieve the set objectives, in 1964, the University created two more Faculties, namely Education and Economics & Social Studies [now Faculty of Social Sciences]. The fifth faculty [School of Agriculture] was established in 1975. The Faculty of Science was split into the Schools of Physical and Biological Sciences during the 2002/2003 academic year while the Department of Business Studies was also elevated to the School of Business with effect from the 2003/2004 academic year.

The National Accreditation Board (NAB), at its 63rd Meeting held on October 4, 2007 approved a three-year Interim Accreditation for the running of the Basic Sciences component of the Bachelor of Medicine and Bachelor of Surgery (MB CHB) programme at the School of Medical Sciences of the University of Cape Coast. In view of this, the School of Medical Sciences became fully operational when on Thursday, 17th January, 2008 the first batch of students was matriculated.

In order to make graduate studies more relevant and responsive with research related to the economy, the Board of Graduate Studies was changed to the School of Graduate Studies and Research (SGSR) with renewed and enhanced mandate with modules that will focus on action and demand-driven research.

The University has expanded the scope of its sandwich programmes to include M.Ed. [Admin], M.Ed. [Management], M.A. [Human Resources Management], M.A. [Human Resources Development], and M.A. [Democratic Governance, Law and Development, Environmental Management Policy and M.A. [Governance and Sustainable Development], as well as M.A. and M.Ed. [Guidance and Counselling]. The following programmes: B.Com. B.M.S. and B.Sc. [Marketing] have been designed for H.N.D. holders. The University also runs sandwich programmes at diploma, graduate and postgraduate levels in Organisation Development [O.D.].

Similarly, in the 2005/2006 academic year, the University introduced other new programmes namely, B.Ed. (Management), B.Sc. (Psychology), B.Sc. (Medical Laboratory Technology) and B.Sc. (Nursing). Additionally, an M.Ed. (Information & Communication Technology) was also introduced in the same year under the Centre for Continuing Education. The new programmes are to cater for the academic and professional needs of individuals, institutions and organisations whose activities relate to these programmes. With the introduction of these new programmes, the University

has phased out its B.Ed. (Foundations) and B.Ed. (Population and Family Life) programmes. The 2007/2008 academic year also saw the introduction of new programmes at the graduate level in the Institute of Development Studies, namely M.A. (Development Studies), M.Phil. (Development Studies), M.A. (Development Management) and M.Phil. in Peace and Development Studies. The Department of Physics also introduced a sandwich programme in B.Sc. Engineering Physics for H.N.D. holders.

Since 1996, the University has restructured its degree programmes by de-coupling the study of professional education courses from the main degree course. This was done to allow flexibility and choice in its course offerings, and thus cater for specific needs of students, while still focusing on its traditional mission of producing highly qualified and skilled labour in education. In this regard, approximately 50% of students are admitted into the Faculty of Education (now College of Education Studies) to pursue Bachelor of Education programmes, qualifying as professional teachers, and the rest admitted into non-education programmes in the other faculties.

In response to the changing needs of society and those of the entire Ghanaian education enterprise, the University of Cape Coast has, over the last several years, progressively added to its traditional functions, the training of educational planners, administrators, agriculturalists, actuarial scientists, optometrists, information technologists, biochemists, environmentalists, laboratory technologists and experts in commerce, management, tourism, population and family life education, water and sanitation, molecular biology, biotechnology, computer science and livestock system managers.

The University is organised into 15 Faculties/Schools, and runs many programmes in order to meet the changing needs of society. The University has also been running its programmes on regular, sandwich and distance basis. With effect from 1st August, 2014, the University has been operating under 5 colleges which are the College of Humanities and Legal Studies; College of Agricultural and Natural Sciences; College of Health and Applied Sciences; College of Education Studies; and College of Distance Education headed by Provosts. From an initial student enrolment of 155 in 1963, the University of Cape Coast now has a total student population of over 35,922. The breakdown is as follows: 14,815 Regular Undergraduate Students, 2,146 Sandwich Students and 18,018 Distant Learning Students.

As part of its desire to vigorously promote distance education, the College of Distance Education (CoDE), formerly Centre for Continuing Education (CCE), has acquired sites in seven out of ten regions for the construction of permanent study centres. The centres will eventually serve as UCC campuses in the regions to run some campus-based programmes. Additionally, there is a six billion Ghana cedi IGF funded building complex completed for the College of Distance Education (CoDE).

### ***Motto***

The motto of UCC is “Veritas Nobis Lumen” which means “Truth, Our Guide”

### ***Vision Statement***

“To have a University that is strongly positioned, with world-wide acclaim”

This statement of where the University sees itself in the future sets the tone for every strategic decision or choice that it has made. It sets the ambition of the organization and serves as the lodestar that every faculty, school, department, functional division and individual must aspire to. In combination with its mission statement, University of Cape Coast has articulated a view of a realistic, credible, attractive future for itself; a target that inspires all stakeholders to maximum effort in bridging the gap between their current reality and their desired future.

### ***Mission Statement***

“The University of Cape Coast is the University of Choice”

It is an equal opportunity university uniquely placed to provide quality education through the provision of comprehensive, liberal and professional programmes that challenge learners to be creative, innovative, and morally responsible citizens. Through distance learning, it also extends expertise and facilities to train professionals for the education enterprise and business by employing modern technologies. The University constantly seeks alternative ways to respond to changing needs. The institution continues to expand its existing highly qualified academic and administrative staff, offering a conducive environment that motivates them to position the University to respond effectively to the developmental needs of a changing world”.







# RESEARCH ACTIVITIES IN THE COLLEGES

## COLLEGE OF AGRICULTURE AND NATURAL SCIENCES

### *Introduction*

*The College of Agriculture and Natural Sciences (CANS) is one of the five colleges at the University of Cape Coast (UCC). It was instituted together with four other colleges at UCC on Friday, 1st August, 2014. It comprises three schools which are the School of Agriculture, School of Biological Sciences, and the School of Physical Sciences. The Schools under CANS offer multiple undergraduate and graduate programmes that seek to address the University's vision, mission and philosophy. CANS sees the need to forge ahead strategically to support its three schools to achieve their objectives and to further help the University achieve its vision and mission.*



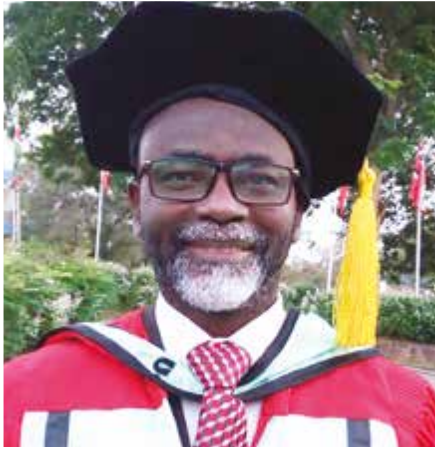

**Professor Livingstone Sam-Amoah,**  
Provost of the College of Agriculture and Natural Sciences

In order for the College to excel and remain competitive and relevant, a strategic plan has been developed to serve as a tool to give direction and to help realise its goals.

The strategic plan of CANS addresses issues concerning teaching, research and extension services of all its three schools. It aims at conscientiously encouraging its schools to be pro-active in: promoting a conducive teaching and learning environment coupled with a sound student/staff relationship; developing more demand-driven academic programmes (regular, sandwich and undergraduate) and relevant curricula; increasing research output; engaging in collaboration/linkage with relevant local and foreign stakeholders; embarking on more income generating activities, while enforcing fiscal discipline; acquiring, developing and completing all projects as scheduled and finally promoting a congenial working environment for both teaching and non-teaching staff to support research, teaching and learning all geared towards supporting the university's mission of challenging its products to be creative, innovative and morally responsible.

### ***Vision Statement***

The vision of the College is to be an internationally recognised College of the University of Cape Coast strongly positioned as a centre of excellence in teaching, research and extension services.

### ***Mission Statement***

The College of Agriculture and Natural Sciences has positioned itself to enable the Schools of Biological, Physical, and Agriculture Sciences to:

- prepare undergraduate and post-graduate students to become productive scientists and educators;
- render extension services to upgrade farmers, fisher folk and other stakeholders with research-based knowledge to increase their agricultural productivity;
- collaborate and link up with other relevant stakeholders to achieve the vision of the college;
- attract, retain and develop outstanding diverse academic and support staff for achieving the college's vision;
- ensure gender mainstreaming to promote sustainable developed; and
- promote collaboration among the three (3) schools of the College in harmonising physical, human, material and financial resources to achieve the College's vision.

No.	Grant Type	Title of Project	Principal Investigator(s)/ Stakeholders	Department(s)	Source of Funding	Total Amount	Status of Project
<b>SCHOOL OF AGRICULTURE</b>							
4	Collaborative Project	Promoting the Incorporation of Soyabean in Poultry Feed in Ghana	Prof. Joseph D. Owusu- Sekyere; Prof. Ernest E. Abano; Dr. Ernest Teye; Dr. Robert S. Amoah;  Dr. Julius K. Hagan; and Mr. Samuel Akuamoah-Boateng (UCC, Ghana)	Department of Agricultural Engineering, UCC, Ghana  Department of Animal Science, UCC, Ghana  Department of Agricultural Economics & Extension, UCC, Ghana	United States Department of Agriculture (USDA)	USD50,000.00	Completed (2016)
5	Supervised Enterprise Development Project	Ministry of Food and Agriculture (MoFA)	Prof. Ernest E. Abano (UCC, Ghana)	Department of Agricultural Engineering, UCC, Ghana	MoFA UCC	GHC20,000.00	On-going
6	SHARE Scholar Award	Sharing Capacity to Build Capacity for Quality Training in Agriculture in African University (SHARE): Effect of Pretreatments on the Drying of Jack Fruits in Uganda	Dr. Ernest Teye (UCC, Ghana)  Prof. W. Kyamuhangire; and Dr. Sidney N. Obidimma (Makerere University, South Africa)	Department of Agricultural Engineering, UCC  Department of Food Science & Nutrition, Makerere University, South Africa	SHARE-Capacity INTRA-ACP Mobility	EUR4,500.00	Completed (2016)
7	Departmental Research	Design and Fabrication of a Cassava Peeler	Dr. Francis Kumi; Mr. Steven Aikins; Prof. Livingston K. Sam-Amoah; Dr. Robert S. Amoah; Prof. Ernest E. Abano; and Dr. Ernest Teye (UCC, Ghana)	Department of Agricultural Engineering, UCC, Ghana	Departmental Academic Facility User Fee (AFUF)	GHC40,000.00	2016-2018



No.	Grant Type	Title of Project	Principal Investigator(s)/ Stakeholders	Department(s)	Source of Funding	Total Amount	Status of Project
-----	------------	------------------	---	---------------	-------------------	--------------	-------------------

### SCHOOL OF AGRICULTURE

1	Capacity Building Project	Training in Integration of Beekeeping into Cashew Farms to Improve Income of Farmers in the Transitional Ecological Zone of Ghana	Prof. Festus Annor-Frempong; Dr. William Charley; and Dr. Joseph Agyenim-Boateng (UCC, Ghana)  Dr. Kwame S. Aidoo; and Mr. Ferdinand Tornnye (Beekeeping Consultants)	Department of Agricultural Economics & Extension, UCC, Ghana  Beekeeping Centre, Saltpond, Ghana  National Beekeeping Association of Ghana	Council for Technical and Vocational Education and Training/ Skills Development Fund (COTVET/ SDF)	GHC68,457.20	Completed (2014-2016)
---	---------------------------	---	---	--	--	--------------	-----------------------

2	Departmental Research Project	Joint Case Study on Economic Benefits and Sustainability of Maize Smallholder Farmers in the Northern Ghana: The Case of Brong Ahafo and Ashanti Regions Cluster	Prof. Festus Annor-Frempong; Dr. William Charley; and Dr. Albert O. Mensah (UCC, Ghana)	Department of Agricultural Economics & Extension, UCC, Ghana	World Food Programme	GHC84,812.76	Completed (2016)
3	Collaborative Research between Department and Industry	Assessment of Factors Contributing to the Dwindling Numbers of Students Enrolled into the Diploma in Agricultural Extension Programme at Kwadaso Agricultural College (KAC), Ghana	Prof. Festus Annor-Frempong (UCC, Ghana)  Dr. Kwadwo Amankwa; and Mr. Ebenezer Tawiah (KAC)	Department of Agricultural Economics & Extension, UCC, Ghana  KAC, Ghana	Sasakawa Africa Fund for Extension Education	USD11,000.00	On-going (since 2016)

No.	Grant Type	Title of Project	Principal Investigator(s)/ Stakeholders	Department(s)	Source of Funding	Total Amount	Status of Project
<b>SCHOOL OF AGRICULTURE</b>							
8	Departmental Research	Design and Construction of a Chicken De-feathering Machine	Dr. Francis Kumi; Mr. Steven Aikins; Prof. Livingston K. Sam-Amoah; Dr. Robert S. Amoah; Prof. Ernest E. Abano; and Dr. Ernest Teye (UCC, Ghana)	Department of Agricultural Engineering, UCC, Ghana	Departmental AFUF	GHC40,000,000	2016-2018
9	Inter-Departmental Research	Systematic Review & Meta-Analysis of Food Security Interventions in Ghana	Dr. Michael O. Adu; Dr. David O. Yawson; Prof. Frederick A. Armah Prof. Ernest E. Abano; (UCC, Ghana) Dr. Reginald Quansah (UG, Ghana)	Department of Crop Science, UCC, Ghana; Department of Soil Science, UCC, Ghana; Department of Environmental Science, UCC, Ghana Department of Agricultural Engineering, UCC,	United States Agency for International Development (USAID); FTF- APSP	USD10,000,000	On-going
10	Inter-Departmental Research Project	Utilisation of Palm Kernel Oil Residue (PKOR) as Feed Ingredient for Poultry and Pigs	Prof. F. N. A. Odoi; Prof. S. O. Apori; Dr. Julius K. Hagan; Dr. Moses Teye; and Mr. Ibrahim Adam (UCC, Ghana)  Prof. D. B. Okai; and Dr. Michael Boateng (KNUST, Ghana)	Department of Animal Science, UCC, Ghana  Department of Animal, KNUST, Ghana	Departmental AFUF	GHC50,000,000	On-going since 2012
11	Capacity Building Project	Building the Capacity of Pig and Grasscutter Farmers	Prof. F. N. A. Odoi; Prof. S. O. Apori; Prof. A. Annan-Prah; Dr. Julius K. Hagan; Dr. Moses Teye; and Mr. Ibrahim Adam (UCC, Ghana)	Department of Animal Science, UCC, Ghana	COTVET/SDF	GHC100,000,000	Completed (2012-2014)



No.	Grant Type	Title of Project	Principal Investigator(s)/ Stakeholders	Department(s)	Source of Funding	Total Amount	Status of Project
-----	------------	------------------	---	---------------	-------------------	--------------	-------------------

### SCHOOL OF AGRICULTURE

12	Collaborative Research between Department and Industry	Incorporation of Heat-tolerant Genes in Exotic Layers for Increased Egg Production under Heat-stress Environments	Dr. Julius K. Hagan (UCC, Ghana) Dr. K. Adomako; and Dr. O. S. Olympio (KNUST, Ghana)	Department of Animal Science, UCC, Ghana Department of Animal, KNUST, Ghana	Department of Animal Science, UCC, Ghana	GH¢300,000,000	On-going since 2009
----	--	---	---	--	--	----------------	---------------------

13	Research Grant	Incidence of Viral Diseases of Okra in the Central Region and Identifying Resistant Varieties	Prof. Elvis Asare-Bediako (UCC, Ghana)	Department of Crop Science, UCC, Ghana Department of Soil Science, UCC, Ghana Department of Molecular Biology & Biotechnology, UCC, Ghana Department of Biochemistry, UCC, Ghana Department of Physics, UCC, Ghana	DRIC, UCC, Ghana	GH¢150,000,000	Completed
----	----------------	---	--	--	------------------	----------------	-----------

14	Research Grant	Development of Appropriate Strategies for the Management of Taro Leaf Blight Disease in the Eastern Region	G. C. van der Puije	Department of Crop Science, UCC, Ghana Department of Agricultural Economics & Extension, UCC, Ghana Ghana CSIR-PGRI CSIR-CRI MoFA	West African Agricultural Productivity Programme	GH¢150,000,000	3rd and Final year
----	----------------	--	---------------------	---	--	----------------	--------------------

No.	Grant Type	Title of Project	Principal Investigator(s)/ Stakeholders	Department(s)	Source of Funding	Total Amount	Status of Project
<b>SCHOOL OF AGRICULTURE</b>							
15	Research Grant	Development of Appropriate Strategies for the Management of Maize Streak Disease in Volta Region	Prof. Elvis Asare-Bediako	Department of Crop Science, UCC, Ghana CSIR-CRI MoFA	West African Agricultural Productivity Programme	GHC202,400.00	On-going
16	Research Grant and Capacity Building	Green Cohesive Agricultural Resource Management	Dr. Kingsley J. Taah; and Dr. Kwame Agyei-Frimpong (UCC, Ghana)	Department of Crop Science, UCC, Ghana Department of Soil Science, UCC, Ghana	Denmark International Development Agency (DANIDA) Fellowship Centre	GHC478,327.45	On-going
17	Departmental Project	Development of CMD Resistant Cassava Varieties with High Beta-carotene and High Root Yield	Prof. Elvis Asare-Bediako; P. A. Asare; and Dr. Kingsley J. Taah (UCC, Ghana) G. Amenorpe	Department of Crop Science, UCC, Ghana BNARI GAEC CSIR-CRI	Department of Crop Science, UCC, Ghana	-----	-----
18	Research Grant	Systematic Review and Meta-analysis of Food Security in Ghana	Dr. Michael O. Adu; Dr. David O. Yawson; Prof. Frederick A. Armah Prof. Ernest E. Abano (UCC, Ghana) R. Quansah (UG, Ghana)	School of Agriculture, UCC, Ghana School of Biological Sciences, UCC, Ghana School of Public Health, University of Ghana, UG, Ghana	USAID/Ghana Feed the Future (FtF) Agriculture Policy Support Project (APSP)	GHC41,172.30	On-going (≈50% complete)



No.	Grant Type	Title of Project	Principal Investigator(s)/ Stakeholders	Department(s)	Source of Funding	Total Amount	Status of Project
-----	------------	------------------	---	---------------	-------------------	--------------	-------------------

### SCHOOL OF AGRICULTURE

19	Research Grant	Pesticide Use Practices and Perceptions of Vegetable Farmers in the Cocoa Belts of the Ashanti and Western Regions of Ghana	Prof. Elvis Asare-Bediako; and Prof. J. A. Micah (UCC, Ghana)	Department of Crop Science, UCC, Ghana Department of Agricultural Economics & Extension, UCC, Ghana	AVRDC	-----	Completed
20	Capacity Building	Training of Peace and Love Vegetable Growers Association in Modern Agronomic Practices, Safe User of Pesticides, Hygienic Practices and Basic Principles of Marketing Vegetables	Dr: Kingsley J. Taah; Prof. Elvis Asare-Bediako; G. C. van der Puije; K. M. Nyarko; and Dr. Albert O. Mensah (UCC, Ghana)	Crop Science, UCC, Ghana School of Business, UCC, Ghana Department of Agricultural Economics & Extension, UCC, Ghana	COTVET/SDF	GHC49,365.00	Completed
21	Capacity Building	Training of Assin Nyame Bekyere Oil Palm Processing Association in Modern and Innovative Agronomic Practices for Increased Productivity in Oil Palm Cultivation	Dr. Kingsley J. Taah Prof. Elvis Asare-Bediako G. C. van der Puije	Department of Crop Science, UCC, Ghana	COTVET/SDF	GHC36,900.00	Completed

No.	Grant Type	Title of Project	Principal Investigator(s)/ Stakeholders	Department(s)	Source of Funding	Total Amount	Status of Project
<b>SCHOOL OF AGRICULTURE</b>							
22	Capacity Building	Training of Assin Dawmako Nyameyie Co-operative Farmers Society in Modern and Innovative Agronomic Practices for Increased Productivity in Oil Palm Cultivation	Dr. Kingsley J. Taah; Prof. Elvis Asare-Bediako; Dr. G. C. van der Puijje; and Y. Opoku-Asiamah (UCC, Ghana)	Department of Crop Science, UCC, Ghana	COTVET/SDF	GHC43,800,000	Completed
23	Capacity Building	Training of Pineapple Farmers in 10 Communities of Ekumfi in Appropriate Practices in Organic Pineapple Production	Dr. Kingsley J. Taah; Dr. G. C. van der Puijje; and Dr. Kwame Agyei-Frimpong (UCC, Ghana)	Department of Crop Science, UCC, Ghana Department of Soil Science, UCC, Ghana CEDECOM, Ghana	Japan Government	-----	Completed
24	Collaborative Research Project	Assessing the potential of <i>Dioscorea praehensilis</i> (Bush yam) as a commercial and food security crop in Ghana.	Prof. Jonathan P. Tetteh Dr. Michael O. Adu, Dr. David O.Yawson, Dr. Obeng Mensah.	Department of Crop Science, UCC, Ghana; Department of Soil Science, UCC, Ghana; Department of Agricultural Extension, UCC, Ghana.	The Regional Universities Forum for Capacity Building in Agriculture (RUFORUM), Graduate Research Grant	US\$ 58,873,000	Completed (2012-2014)

No.	Grant Type	Title of Project	Principal Investigator(s)/ Stakeholders	Department(s)	Source of Funding	Total Amount	Status of Project
-----	------------	------------------	---	---------------	-------------------	--------------	-------------------

### SCHOOL OF BIOLOGICAL SCIENCES

25	Collaborative Research Project	Utilisation of Sweet Potato ( <i>Ipomoea batatas</i> ) in Composite Flour Production	Dr. Enoch T. Quayson; Dr. Martin Bosompem; and Prof. Henry D. Acquah (UCC, Ghana)  Mrs. Anna Amoako-Mensah (UG, Ghana)	Department of Biochemistry, UCC, Ghana Department of Agricultural Economics & Extension, UCC, Ghana Department of Dietetics, School of Allied Health Sciences, UG, Ghana	Nutrition Third World, Brussels, Belgium	EUR29,879,000	Completed (2012-2014)
26	Individual Research Grant	Influence of Thermal Processing on the Nutrient Content and Shelf-life of Soursoop Juice	Dr. Jerry Ampofo-Asiama (UCC, Ghana)	Department of Biochemistry, UCC, Ghana	International Foundation for Science	USD11,500,000	On-going (2016-2017)

27	Consultancy Project	Development of a Guide to Fish Caught and Processed using Illegal Fishing Methods	Prof. Denis W. Aheto; and Dr. Richmond Afoakwah (UCC, Ghana)	Centre for Coastal Management, UCC, Ghana Department of Forensic Sciences, UCC, Ghana	USAID Sustainable Fisheries Management Project of the University of Rhode Island, USA	GHC37,000,000	2017 (4 months)
----	---------------------	---	--	--	---	---------------	-----------------

28	Collaborative Research Project	Birds, Bees and Butter Project - Enhancing Ecosystem Services in the Shea Parklands of sub-Sahara Africa (Ghana and Burkina Faso)	Prof. Peter Kwapong (UCC, Ghana) Ghana Wildlife Society Jane Stout Issa Nombre Naturama, Cath Tayleur	Department of Conservation Biology & Entomology, UCC Cape Coast, Ghana University College of Dublin University of Ouagadougou, Burkina Faso Ouagadougou, Burkina Faso Birdlife International, Cambridge, UK	LUSH UK		Completed (2015-2016)
----	--------------------------------	---	---	---	---------	--	-----------------------



No.	Grant Type	Title of Project	Principal Investigator(s)/ Stakeholders	Department(s)	Source of Funding	Total Amount	Status of Project
<b>SCHOOL OF BIOLOGICAL SCIENCES</b>							
29	Collaborative Research Project	Black Soldier Fly as Engineers for Municipal Waste Management, Compost Production and as Food for Fish	Prof. Peter Kwapong (UCC, Ghana) BNARI, GAEC, Ghana Fbil, Switzerland	Department of Conservation Biology & Entomology, UCC, Ghana	-----	-----	On-going (2015-2017)
30	Collaborative Research Project	Valorization of Green Agriculture in Africa (Ghana, Kenya, Tanzania and Denmark)	Prof. Henrik Egelyng (University of Copenhagen, Denmark, Faculty of Science (KU)) Prof. Peter Kwapong (UCC, Ghana) Dr. John I. Mboru (University of Nairobi, Kenya) Dr. Rasack B. Lokina; and Dr. Faustin P. Maganga (University of Dar es Salaam, Tanzania) Prof. Joseph A. Yaro (UG, Ghana)	Department of Food and Resource Economics (KU), University of Copenhagen (KU), Denmark, Faculty of Science (KU) Department of Conservation Biology & Entomology, UCC, Ghana Department of Agricultural Economics, University of Nairobi, Kenya Department of Economics & Environment for Development, University of Dar es Salaam, Tanzania Institute of Research Assessment, University of Dar es Salaam, Tanzania Department of Geography and Resource Development	DANIDA	DKK9977,540.00	On-going (2014-2017)

No.	Grant Type	Title of Project	Principal Investigator(s)/ Stakeholders	Department(s)	Source of Funding	Total Amount	Status of Project
-----	------------	------------------	---	---------------	-------------------	--------------	-------------------

### SCHOOL OF BIOLOGICAL SCIENCES

31	Collaborative Research Project	Global Pollination Project (GPP): Conservation and Management of Pollinators for Sustainable Agriculture through an Ecosystem Approach	Prof. Peter Kwapong (UCC, Ghana)  <i>Partners: (Brazil, Kenya, South Africa, Pakistan, India and Nepal)</i>	Department of Conservation Biology & Entomology, UCC, Ghana Brazil: Ministry of the Environment (MMA) India: GB Pant Institute of Himalayan Environment and Development Kenya: National Museums of Kenya Nepal: Ministry of Agricultural Development (Food Security and Environment Division) Pakistan: Pakistan Agricultural Research Council South Africa: South Africa National Biodiversity Institute Biodiversity Institute	UNEP/GEF/FAO funded	USD12,000,000.00	Completed (2009-2015)
32	Individual Research	Monitoring Insecticide Resistance in <i>Anopheles</i> , <i>Culex</i> and <i>Aedes</i> Mosquitoes and their Impact on Mosquito Control Strategies used at the Household Level	Ghana Wildlife Society Dr. Andreas A. Kudom (UCC, Ghana)	Department of Conservation Biology & Entomology, UCC, Ghana	Self-funded	GHC8,000.00	On-going

No.	Grant Type	Title of Project	Principal Investigator(s)/ Stakeholders	Department(s)	Source of Funding	Total Amount	Status of Project
<b>SCHOOL OF BIOLOGICAL SCIENCES</b>							
33	Performance Production Grant	Evaluation of Efficacy of Aqueous Neem Leaf Extract against Pyrethroid-resistant <i>Anopheles</i> Larvae	Dr. Andreas A Kudom (UCC, Ghana)	Department of Conservation Biology & Entomology, UCC, Ghana	TWAS (15-233 RG/ BIO/AF/AC.I - FR3240287067)	USD10,000,000	On-going (2015-2017)
34	Individual Project	Characterisation of Organic Pollution in Mosquito Breeding Sites using Fluorescence Spectroscopy	Dr. Andreas A. Kudom; and Dr. Baah Sefa-Ntiri (UCC, Ghana)	Department of Conservation Biology & Entomology, UCC, Ghana  Laser and Fibre Optics Centre (LAFOC), Department of Physics, UCC, Ghana	Self-funding	GHC5,000,000	On-going
35	Performance Production Grant	A Survey of Mosquito Fauna and Assessment on Knowledge of Mosquito Life History among Inhabitants of Cape Coast, Ghana	Dr. Andreas A Kudom (UCC, Ghana)	Department of Conservation Biology & Entomology, UCC, Ghana	British Ecological Society	GBP8,000,000	Completed (2013-2015)
36	Consultancy Project	Jimi Dam Sediment Profile Study, Anglogold Ashanti Limited (Obuasi Mine)	Ernest A. Afrifa (UCC, Ghana)	Department of Environmental Science, UCC, Ghana	AngloGold Ashanti Limited	GHC15,000,000	Completed (2012)



No.	Grant Type	Title of Project	Principal Investigator(s)/ Stakeholders	Department(s)	Source of Funding	Total Amount	Status of Project
-----	------------	------------------	---	---------------	-------------------	--------------	-------------------

### SCHOOL OF BIOLOGICAL SCIENCES

37	Consultancy Project	Pit Water Profiling and Quality Assessment of the Block 7/8 Pit, Block 3 Valley, Teberebel and UEE Dams of AngloGold Ashanti Iduapriem Ltd.	Ernest A. Afrifa (UCC, Ghana)	Department of Environmental Science, UCC, Ghana	AngloGold Ashanti Limited	GH¢29,000,000	Completed (2012)
38	Consultancy Project	Bathymetric Study of the Sibi North (Gyabunso) Open Pit, AngloGold Ashanti Ltd., Obuasi	Ernest A. Afrifa (UCC, Ghana)	Department of Environmental Science, UCC, Ghana	AngloGold Ashanti Limited	GH¢29,390,000	Completed (2013)
39	Performance Production Grant	Groundwater Studies around the South and East Tailings Storage Facilities (TSFs) of Goldfields Ghana Ltd., Darmang Mine	Ernest A. Afrifa (UCC, Ghana)	Department of Environmental Science, UCC, Ghana	Goldfields Ghana Ltd.	GH¢19,000,000	Completed (2014)
40	Consultancy Project	Ernest Amankwa Afrifa Profile Sampling, Water and Sediment Quality Assessment of Water Bodies at Kinross Chirano Gold Mine, Ghana	Ernest A. Afrifa (UCC, Ghana)	Department of Environmental Science, UCC	Kinross Chirano Gold Mine, Ghana	GH¢35,000,000	Completed (2014)

No.	Grant Type	Title of Project	Principal Investigator(s)/ Stakeholders	Department(s)	Source of Funding	Total Amount	Status of Project
<b>SCHOOL OF BIOLOGICAL SCIENCES</b>							
41	Consultancy Project	Dredging of Ntakofam River under the Local Climate Change Adaptive Living (local) Project for Dry Season Vegetable Production at Effutu Municipal Assembly, Winneba - Central Region	Dr. Mohammed A. Takase (UCC, Ghana)	Department of Environmental Science, UCC, Ghana	Canadian International Development Agency (CIDA)	USD5,500,000	Completed (2014)
42	Collaborative Research Project	Environmental Monitoring and Impact Assessment of High Risk Analytes in Produced Water from Oil and Gas industry	Dr. Michael Miyittah; Dr.-Ing. Samuel K. Tulashe; and Dr. Francis Nsiah (UCC, Ghana)	Department of Environmental Science, UCC, Ghana  Department of Chemistry, UCC, Ghana	Organisation for the Prohibition of Chemical Weapons (OPCW) Research	EUR22,800,000	Completed (2015)
43	Collaborative Research Project	Application of Nanotechnology for Underground Water Treatment Assisted by Laser Light Techniques	Dr. Michael Miyittah; Dr. Baah Sefa-Ntiri; Dr. Benjamin Anderson; and P. K. Amoah Mensah  Dr. Francis Nsiah; and Dr.-Ing. Samuel K. Tulashe (UCC, Ghana)	Department of Environmental Science, UCC, Ghana Department of Physics, UCC, Ghana  Department of Physics, UCC, Ghana Department of Chemistry, UCC, Ghana	DRIC, UCC	GHC20,000,000	Completed (2014)

No.	Grant Type	Title of Project	Principal Investigator(s)/ Stakeholders	Department(s)	Source of Funding	Total Amount	Status of Project
<b>SCHOOL OF BIOLOGICAL SCIENCES</b>							
44	Consultancy Project	Bathymetric Survey and Water Volume Estimation For the Tailings Storage Facility 2, Obra and Sariehu Pits of Kinross Chiranos Gold Mine, Ghana	Ernest A. Afrifa (UCC, Ghana)	Department of Environmental Science, UCC, Ghana	DRIC, UCC Kinross Chiranos Gold Mine	GH¢25,500,000	Completed (2015)
45	Collaborative Research Project	Field Investigation of Pesticides Practice and Risk Assessment in Cocoa Growing Areas of Western region of Ghana	Dr. Michael Miyittah (UCC, Ghana) Prof. Ole M. Eklo ( <i>Norwegian Institute of Bioeconomy Research, Norway</i> ) Mr. Joel B. Painsill ( <i>Norwegian University of life Sciences, Norway</i> )	Department of Environmental Science, UCC, Ghana Norwegian Institute of Bioeconomy Research, Norway Norwegian University of life Sciences, Norway	Norwegian University of life Sciences, Norway Department of Ecology & Management of Natural Resources	USD2,000,000	Completed (2016)
46	Institutional Capacity Strengthening Grant and Operationalization of the Centre for Coastal Management	Fisheries and Coastal Management Capacity Building Support Project	Prof. Dennis W. Aheto; and Dr. Noble Asare (UCC, Ghana)	Department of Fisheries & Aquatic Sciences, UCC, Ghana	USAID	USD5,500,000,000	Under Implementation phase (2014-2019)



No.	Grant Type	Title of Project	Principal Investigator(s)/ Stakeholders	Department(s)	Source of Funding	Total Amount	Status of Project
<b>SCHOOL OF BIOLOGICAL SCIENCES</b>							
47	Capacity Building Project	Public-Private Partnership to Establish a Fish Farming Training Centre of Excellence in Ghana	Prof. Denis W. Aheto; and Dr. Emmanuel Acheampong (UCC, Ghana) Mr. Jacob Ainoo-Ansah (Ainoo-Ansah Farms)	Department of Fisheries & Aquatic Sciences, UCC, Ghana	COTVET with funding from World Bank and DANIDA	GHC1,330,382.00	Completed (2014-2016)
48	Collaborative Research Project	Fishing for Security Project	Prof. Denis W. Aheto; and Prof. John Blay	Department of Fisheries & Aquatic Sciences, UCC, Ghana	Australian Aid	AUS60,000,000	Completed (2015)
49	Collaborative Project	Development of Wetlands Educational Curricula for Junior High Schools in Ghana	Prof. John Blay; and Prof. Denis W. Aheto (UCC, Ghana)	Department of Fisheries & Aquatic Sciences, UCC, Ghana	USAID	USD15,000,000	Completed (2015)
50	Capacity Building Project for Professionals	Climate Change Adaptation Short Course	Prof. Denis W. Aheto (UCC, Ghana)	Department of Fisheries & Aquatic Sciences, UCC, Ghana	USAID	GHC50,000,000	Completed (2012)
51	Short Term Training for NGOs	Integrated Coastal Zone Management	Prof. John Blay; and Prof. Denis W. Aheto (UCC, Ghana)	Department of Fisheries & Aquatic Sciences, UCC, Ghana	USAID	GHC3,080,000	Completed (2012)
52	Collaborative Research Project	Identification and Characterisation of Ghanaian Cowpea ( <i>Vigna unguiculata</i> L. Walp) Accessions Resistant to the Parasitic Weed <i>Striga gesnerioides</i> using Microsatellite Markers	Dr. Aaron Tettey-Asare (UCC, Ghana)	Department of Molecular Biology & Biotechnology, UCC, Ghana	Global Crop Diversity Trust Project	GHC11,268,000 USD9,000,000	Completed (2011)

No.	Grant Type	Title of Project	Principal Investigator(s)/ Stakeholders	Department(s)	Source of Funding	Total Amount	Status of Project
-----	------------	------------------	---	---------------	-------------------	--------------	-------------------

### SCHOOL OF BIOLOGICAL SCIENCES

53	Individual Research Project	Fungal Biodiversity and Conservation in the Kakum National Park, Ghana-	Dr. Levi Yefetto (UCC, Ghana)	Department of Molecular Biology & Biotechnology, UCC, Ghana	The Rufford Small Grants Foundation	GBP5,620.00	June 2013 - July 2014
----	-----------------------------	---	-------------------------------	---	-------------------------------------	-------------	-----------------------

54	Collaborative Research Project	Sustainable Utilisation of Cowpea Genetic Resources for Enhanced Food Security and Poverty Alleviation in the Dry Savannah Northern Regions of Ghana	Dr. Aaron Tettey-Asare; Prof. Isaac K. A. Galyuon; and Dr. Sheila Tagoe Mr. David C. Adulkpo; Prof. Elvis Asare-Bediako; Prof. B. A. Mensah; Dr. Kwame Agyei-Frimpong; and Dr. (Mrs.) Genevive Adulkpo (UCC, Ghana) Dr. Lawrence M. Aboagye Mr. Francis Kusi Prof. Michael. P. Timko (University of Virginia, USA)	Department of Molecular Biology & Biotechnology, UCC, Ghana Department of Physics, UCC, Ghana Department of Crop Science, UCC, Ghana Department of Conservation Biology & Entomology, UCC, Ghana Department of Soil Science, UCC, Ghana Department of Chemistry, UCC, Ghana Plant Genetic Resources Research Institute, Bunso, Ghana Savannah Agriculture Research Institute, Tamale, Ghana Department of Biology, University of Virginia, USA	ITPGRFA/FAO	USD198,792.00	On-going
----	--------------------------------	--	--	--	-------------	---------------	----------

No.	Grant Type	Title of Project	Principal Investigator(s)/ Stakeholders	Department(s)	Source of Funding	Total Amount	Status of Project
<b>SCHOOL OF BIOLOGICAL SCIENCES</b>							
55	Collaborative MSc	Effect of Sacred Grove Size and Isolation Distance on Avifaunal Assemblages in Forest-savanna Transition Zone of Ghana	Dr. Justus P. Deikumah; and Mr. Abraham Yeboah ( <i>UCC, Ghana</i> )	British Trust for Ornithology, UK UCC, Ghana A. P. Leventis Ornithological Research Institute, (APLORI) University of Jos, Nigeria	British Trust for Ornithology, UK	USD10,000.00	Completed (2014-2016)
56	Capacity Training	Indigenous Vulture Monitoring Project (IVMP)	Indigenous Vulture Monitoring Project (IVMP) Dr. Justus P. Deikumah; Mary Adjei-Ayiah; Mr. Richard Kwafo; and Prof. K. A. Monney ( <i>UCC, Ghana</i> )	Rufford Small Grant Department of Conservation Biology & Entomology, UCC, Ghana	Rufford Small Grant	EUR5,000.00	On-going
57			Dr. Justus P. Deikumah; Mary Adjei-Ayiah; Mr. Richard Kwafo; and Prof. K. A. Monney ( <i>UCC, Ghana</i> )	Mohammed Bin Zayed Species Conservation Fund, United Arab Emirates Department of Conservation Biology & Entomology, UCC, Ghana	Mohammed Bin Zayed Species Conservation Fund, United Arab Emirates	USD 12,500.00	On-going
58		Awareness on Straw-Coloured Fruit Bat Invasion on UCC Campus	Prof. K. A. Monney; Dr. Justus P. Deikumah; Mary Adjei-Ayiah; and Mr. Richard Kwafo ( <i>UCC, Ghana</i> )	Department of Conservation Biology & Entomology, UCC, Ghana	UCC, Ghana	GHC10,000.00	Completed



No.	Grant Type	Title of Project	Principal Investigator(s)/ Stakeholders	Department(s)	Source of Funding	Total Amount	Status of Project
-----	------------	------------------	---	---------------	-------------------	--------------	-------------------

### SCHOOL OF BIOLOGICAL SCIENCES

59		Campus Bat Control Project - UCC	Prof. K. A. Monney; Dr. Justus P. Deikumah; Mary Adjei-Ayiah; and Mr. Richard Kwafu (UCC, Ghana)	Department of Conservation Biology & Entomology, UCC, Ghana	UCC, Ghana	USD39,594.00	Implementation Phase 2 (2016)
----	--	----------------------------------	--	---	------------	--------------	-------------------------------

### SCHOOL OF PHYSICAL SCIENCES

60	Research Grant	Environmental Monitoring and Impact Assessment of High-Risk Analytes in Produced Water from Oil and Gas Industry	Dr.-Ing. Samuel K. Tulashie; Dr. Francis Nsiah; and Dr. Michael Mivittah (UCC, Ghana)	Department of Chemistry, Industrial Chemistry Unit, UCC, Ghana Department of Chemistry, UCC, Ghana Department of Environmental Sciences, UCC, Ghana	Organisation for the Prohibition of Chemical Weapons	EUR18,000.00	On-going (2014-2017)
61	Short Courses Training Network	Water Treatment Processes and Plants	Dr.-Ing. Samuel K. Tulashie (UCC, Ghana)	Department of Chemistry, Industrial Chemistry Unit, UCC, Ghana	Netherlands Fellowship Programme (Nuffic)	EUR4,000.00	Completed (2014-2016)

62	Postdoctoral Fellowship	Enantioselective Crystallisation using Chiral Ionic Liquid"	Dr.-Ing. Samuel K. Tulashie (UCC, Ghana)	Department of Chemistry, Industrial Chemistry Unit, UCC, Ghana	German Academic Exchange Service (DAAD) Postdoctoral Award (2016-2 017)	EUR7000.00	On-going
----	-------------------------	---	---	--	---	------------	----------

63	Training Consultancy	Training of Metropolitan, Municipal, and District Assemblies (MMDAs) in Water, Sanitation and Hygiene (WASH) ICT Applications	Dr. Peter A. Obeng (UCC, Ghana)	Department of Chemistry, UCC, Ghana	Ghana-Netherlands WASH Programme	GhC56,866.00	Completed
----	----------------------	---	---------------------------------	-------------------------------------	----------------------------------	--------------	-----------

No.	Grant Type	Title of Project	Principal Investigator(s)/ Stakeholders	Department(s)	Source of Funding	Total Amount	Status of Project
<b>SCHOOL OF PHYSICAL SCIENCES</b>							
64	Capacity Building	NICHE GHA 194	Dr. Peter A. Obeng (UCC, Ghana)	Department of Chemistry, UCC, Ghana	Nuffic/Niche	EUR919,000,000	On-going
65	Skill Development Grant	Rehabilitation and Production of Glassware's for Senior High Schools in Ghana	DRIC, UCC, Ghana	Department of Chemistry, UCC, Ghana	COTVET/SDF	USD500,000,000	2013-2017
66	Research Grant	DESIGN AND CONSTRUCTION OF AC/DC OPERATED MICROCENTRIFUGE	Benjamin Oteng (UCC, Ghana) Prof. Willie Ofosu, (Penn State University, USA) and (JEW-K, Ghana) Dr: Robert Agbermaffe; Mr. Rex J. S. Okoto; Mr. Hubert Nyarko; and Mr. John K. Otchere (UCC, Ghana)	Department of Laboratory Technology Penn State University, USA	Sole funding	GHC1,000,000	2014-2015
67	Collaborative Research Project	To Study Air Quality using DOAS (Differential Optical Absorption Spectroscopy) in Tema Heavy Industrial Area	Dr. Samuel S. Sackey; Prof. Daniele Treleani; Prof. Joseph J. Niemela; Prof. Giorgio Giovanelli; Dr. Ivan Kostadinov; Dr. Daniele Bortoli; Dr. Samuelle Masieri; Dr. Margherita Premuda; Dr. Elisa Palazzi; Dr. Andrea Petritoli (Italy); Prof. Paul K. Buah-Bassuah (UCC, Ghana); and Osbert S. Akpade		Italian Funds-in-Trust with UNES-CO, TRIL-ICTP	EUR150,000,000	2004-Date

No.	Grant Type	Title of Project	Principal Investigator(s)/ Stakeholders	Department(s)	Source of Funding	Total Amount	Status of Project
-----	------------	------------------	---	---------------	-------------------	--------------	-------------------

### SCHOOL OF PHYSICAL SCIENCES

68	Collaborative Research Project	Tunable Diode Laser Absorption Spectroscopy (TDLAS)	Dr. Benjamin Anderson; and Prof. Paul K. Buah-Bassuah (UCC, Ghana) Prof. Sune Svanberg (Sweden)	LAFOC-UCC Lund Institute of Technology, Lund, Sweden	International Programme for Physical Sciences (IPPS) of International Science Programme (ISP), Uppsala, Sweden	EUR80,000,000	Implementation phase (2016-2021)
----	--------------------------------	---	--	---	--	---------------	----------------------------------

69	Collaborative Research Project	Optical Electronic Speckle Pattern Interferometry (ESPI) Project	Mr. Ebenezer T. Tatchie Prof. Paul K. Buah-Bassuah Prof. Gert von Bally (Germany)	LAFOC, UCC, Ghana Centre for Biomedical and Photonics, University of Munster, Germany	Centre for Biomedical and Photonics, University of Munster Germany and International Centre for Theoretical Physics (ICTP), LAFOC-UCC	EUR10,000,000	2004-Date
----	--------------------------------	--	--	--	---	---------------	-----------

70	Collaborative Research Project	Fourier Transform Infrared (FTIR) Spectroscopy and Quantum Cascade Laser (QCL)	Prof. Moses J. Eghan; and Dr. Benjamin Anderson (UCC, Ghana) Dr. (Mrs.) Akua N. Bentli; Prof. Claire F. Gmachl; and Mr. Charles Lloyd Annuah (USA)	LAFOC-UCC Mid Infrared Technology for Health and Environment (Mirthe) Princeton University	Mirthe, Princeton University	USD500,000,000	2008-Date
----	--------------------------------	--	---	---	------------------------------	----------------	-----------

71	Collaborative Research Project	African Spectral Imaging Network (AFSIN) Project	Prof. Moses J. Eghan; Prof. Johnson Boampong; and Dr. Benjamin Anderson (UCC, Ghana) Prof. Jeremie Zoueu Mr. Jerry O. Ansah	LAFOC-UCC Department of Biomedical Science, UCC ISP, Uppsala University, Sweden; Institut National Polytechnique Félix Houphouët-Boigny, Yamoussoukro, Ivory Coast and other universities from Kenya, Burkina Fasso, Mail, Sri-Lanka, Togo, Camaroon and Senegal	IPPS of ISP, Uppsala, Sweden	USD10,000,000	2009-Date
----	--------------------------------	--	--	--	------------------------------	---------------	-----------



No.	Grant Type	Title of Project	Principal Investigator(s)/ Stakeholders	Department(s)	Source of Funding	Total Amount	Status of Project
<b>SCHOOL OF PHYSICAL SCIENCES</b>							
72	Collaborative Research Project	Ultraviolet (UV) Transparency Research	Dr. Samuel Sonko Sackey; Prof. Moses J. Eghan; Dr. Benjamin Anderson; Dr. Samuel Kyei; Mr. Jerry O. Ansah; Mr. Peter Osei-Wusu Adueming; Charles Lloyd Amuah; and Mr. Andrew A. Huzortey (UCC, Ghana)	LAFOC, UCC, Ghana Department of Optometry, UCC, Ghana	Self-funded	GHC5000000	2015 - Date
73	Collaborative Research Project	Nutmeg Sex Determination, Cowpea and Cassava Projects	Dr. Benjamin Anderson; Prof. Moses J. Eghan; and Prof. Elvis Asare-Bediako (UCC, Ghana)	LAFOC, UCC, Ghana Department of Agricultural Engineering, UCC, Ghana Department of Crop Science, UCC, Ghana	Self-funded	GHC6000000	2012-Date
74	Collaborative Research Project	Purification of Water using Nao-Particles	Dr. Baah Sefa-Ntiri; Dr. Francis Nsiah; Dr. Ing. Samuel K. Tuiashie; and Dr. Benjamin Anderson (UCC, Ghana)	LAFOC, UCC, Ghana Department of Chemistry, UCC, Ghana Department of Environmental Science, UCC, Ghana	DRIC, UCC, Ghana	GHC50,000,000	2014-Date





# DESCRIPTION OF FUNDED RESEARCH & PROJECTS

## *Training in Integration of Beekeeping into Cashew Farms to Improve Income of Farmers in the Transitional Ecological Zone of Ghana*

Members of the National Beekeepers Association (NATBA) from various districts within the Brong Ahafo region of Ghana own large cashew plantations. Beekeeping is done in agricultural landscapes. Integration of bees into cashew pollinate the crops to increase yield and quality fruits and increase honey produced by bees. Members of NATBA lacked skills and technology in integrating beekeeping into agriculture landscapes.

The technology and skills to do all these have been developed by some experts from the Department of Agriculture Economics and Extension of the University of Cape Coast and Saltpond Honey Centre. The project sought to equip cashew farmers and beekeepers with the act of beekeeping in cashew farms (Agriculture landscape) to increase cashew yield by 200% through pollination by bees and generate extra income from harvesting honey and other hive products.

The project also sought to improve farmers' skills and knowledge in economic use of farmlands to achieve more income.

This project was funded by COTVET, started in 2015 and ended in 2016. Hundred members from various districts in Brong Ahafo were trained and used as Trainer of Trainers (ToTs) to reach out to other farmers. Members of the association have embraced the technology and have started giving feedback on how successful the integration is working on their farms. A simple, pictorial and easy to comprehend training manual was developed as reference manual for the farmers.



*Demonstration of siting a bee-hive in agricultural landscape*



*Workshop participants on a tour of Cashew Farm in the Brong Ahafo Region*

## *Joint Case Study on Economic Benefits and Sustainability of Maize Smallholder Farmers in Northern Ghana:*

### *The Case of Brong Ahafo and Ashanti Regions Cluster*

The study was conducted to assess the economic viability and sustainability of maize smallholder farmers' relationship with the various farm business models identified in Brong Ahafo and Ashanti Regions of Ghana. It was to provide empirical data to form the basis for the review of all the interventions made by the Government of Ghana and development partners (The USAID/Ghana Economic Growth Office and World Food Programme) to improve the socio-economic well-being of maize smallholder and low-income farm families under the various farm business models.

The study was funded by World Food Programme (WFP). Forty-nine smallholder farmers were selected purposively from the eleven out grower operators' business models. The WFP collaborated with four Farmer Based Organisations (FBOs), two each in the Ashanti and Brong Ahafo Regions, three nucleus farmers; one from the Brong Ahafo and two from Ashanti; two aggregators and one processor from the Brong Ahafo region, and a warehouse in the Ashanti Region.

The study concluded that relationships of smallholder farmers under various outgrower business operators and farmers' organisation are sustainable. Poor resourced smallholder maize farmers under the outgrower business operators and FBOs have derived various economic benefits through their relationships. Smallholder farmers have adequate access to agricultural technologies and other non-agricultural technologies. They also have moderate access to tractor services for ploughing, harrowing and haulage, grain cleaning services, extension support services, agricultural inputs on credit, cash loans, for agricultural purposes, cash loans for non-agriculture uses, subsidised (or free) inputs, chemical treatment of grains to control storage pests, grain drying services and field pests control services.

Smallholder farmers under the FBOs and other models have increased the production and sales of the surplus; increased yields and mitigated post-harvest losses; improved the quality of products. Only farmers under the aggregator business model recorded the lowest for the minor and major seasons. Smallholder farmers under the processor received the highest profit followed by farmers under the warehouse business model in the major

and minor seasons. The study generally recommended among others the need to provide easy access to credit at lower interest rates and the essential post-harvest inputs, technologies and service facilities, including grain cleaning and drying equipment to farmers and the use of warehouse and processor business operator business model to stimulate more competitions among the various chain actors.





## *Assessment of Factors Contributing to the Dwindling Numbers of Students Enrolled into the Diploma in Agricultural Extension Programme at Kwadaso Agricultural College, Ghana*

The study assessed factors contributing to the dwindling numbers of students enrolled into the Diploma in Agricultural Extension programme at KAC, Ghana and offered recommendations to stakeholders to address the dwindling numbers and improve training of agricultural extension personnel at the Diploma level to contribute to agricultural development. A content validated questionnaire targeting graduates, prospective and current students, users of diploma graduates, tutors and checklist for focus group discussion was used to collect data.

The study concluded that the potential students who are Agricultural Extension Agents (AEAs) of MoFA are aging. The pool of prospective students is likely to be exhausted within the next five to ten years. The graduates of the Diploma in Extension programme assessed the content of the curriculum as appropriate and relevant to their job performance and increased level of competence as a result of the programme. Supervisors, namely the District Directors were concerned about low practical competencies in information and communication technologies (ICT) of graduates.

The unresolved issue of graduates receiving increased salary and status that commensurate with receiving training at the diploma level is a major factor and serves as disincentive for prospective students to enrol into the Diploma in Extension programme. There are gaps in publicity for admission into the Diploma programme between the KAC and Ministry, on the one hand, and the prospective students on the other. There is keen competition from other public and private universities for prospective students. The pool of prospective students is dwindling and those in-service are being frustrated in their bid to further their education.

The study concluded that factors contributing to the dwindling numbers of students enrolled into the Diploma in agricultural extension programme at KAC, Ghana are not inherent in the programme. Key recommendations include the need for Kwadaso to pursue outreach programmes within the districts. The Ghana Government through Ministries of Food and Agriculture, Local Government, Employment and Social Welfare and Finance and Economic Planning should review the relevant policies that affect students enrolment into the programme.

## *Promoting the Incorporation of Soyabean in Poultry Feed in Ghana*

In recent times, there has been considerable interest in the use of plant protein source in animal feed formulation. Soyabean is a source of high quality edible oil for humans, and also a high quality plant protein in animal feed worldwide. Its universal acceptability in animal feed has been due to its high protein content and suitable amino acid, minimal variation in nutrient content, and relative absence of intractable anti-nutritive factors if properly processed. Among the plant protein sources used in animal feed in Ghana, more attention has been focused on soyabean due to the rich nutritional properties coupled with the relatively low cost.

It was against this background that the USDA-funded project on the incorporation of soyabean in the diet of broilers and layers was undertaken in Ghana. The project involved the training of poultry farmer groups drawn from all over the country, namely, Kumasi (Ashanti Region), Takoradi (Western Region), Dormaa Ahenkro (Brong-Ahafo Region), Koforidua (Eastern Region), Cape Coast (Central Region) and Abokobi (Greater Accra Region). The farmers were taken through the use of soyabean meal in feed formulation, testing of feed quality, feed storage and feeding of birds. The other aspect of the training involved the processing of soyabean into oil and cake. They were taken through various methods of processing and how they affect the nutrient composition of the soyabean cake.

At the end of the training, the farmers learnt the various feeding regimes for the various classes of poultry at various stages of growth. They also learnt how to formulate diets for various classes of birds using the various formulation methods. They also learnt how to store feed in order to increase the shelf life.



*Executive of the Dormaa-Ahenkro Poultry Farmers Association with the trainers*



*The research team on a visit to one of the the poultry farms in Dormaa Ahenkro*

### **Supervised Enterprise Development Project**

The objectives of this research was to process soyabean, maize, rice, millet, groundnut, and different spices into ready-to-eat meals and introduce them to farming communities as alternative source of livelihood and income generation activities during the lean season. In this supervised enterprise research, we have processed soyabean into flour, weanmixes of different flavours and introduced them to women farmers at the Ofinso, Atidive, and Assakae communities in the Ashanti, Volta, and Western Regions of Ghana, respectively.



*Weanmix of different flavours produced under the Graduate Enterprise Development Initiative*



*Processed and packaged Dzo / Dakoa under the Graduate Enterprise Development Initiative funded by the Ghana Government and Exim Bank.*

### **Design and Fabrication of a Cassava Peeler**

Cassava (*Manihot Esculenta Crantz*) is an important root crop in sub-Saharan Africa, particularly Ghana where it accounts for 22% of the Agricultural GDP. The diversity of cassava-derived products is unlimited, ranging from a variety of starch-based foods to industrial products such as starch, alcohol, chips and pellets. The diverse uses are promoting the expansion of the cassava industry with a consequent demand for improved processing methods. Peeling of the non-uniformly shaped cassava roots remains a global challenge in the effort to increase throughput capacity in industrial cassava processing. The traditional manual peeling operation can no longer sustain the ever-increasing local and export demand for cassava-derived products. Therefore the aim of this project is to develop a medium technology cassava peeler appropriate for meeting both local and industrial operational capacities. Key features of the mechanised peeler would be simplicity in design for reduced cost, ease of assembling and maintenance, increased throughput capacity and reduced flesh losses. Mechanical considerations such as optimum power requirements, suitability of the construction materials for reduced food contamination, lightweight construction and safety of use would guide the design.

### **Design and Construction of a Chicken De-feathering Machine**

Chicken is often consumed by large portion of the population in Ghana throughout the year and especially, during Christmas and other festive occasions. Although the demand for poultry meat is high, processing of the meat for food, particularly manual feathers removal from the slaughtered birds, could be time-consuming and tedious. This operation could take 5 to 15 minutes per bird depending on its size. Although the meat produced by local poultry farmers are of higher quality compared to the imported ones, they are unable to meet commercial demand for processed poultry products due to constraints in processing. Furthermore, manual handling of the meat exposes them to food contamination. Therefore as part of effort to overcome these challenges and encourage mass processing of chicken meat, it is important to mechanise the operation of removing the feathers. Currently, there is no such locally manufactured machine available on the Ghanaian market. The project therefore aims to develop and test a chicken de-feathering machine, using local materials. The design is targeted at being simple, having high performance efficiency and of low cost. The safety of the food for consumption would also be a key consideration in the selection of the material for fabrication and the overall design concept. The success of this project would result in research publications, patenting of the design and popularisation of the technology for local use.

## *Systematic Review and Meta-analysis of Food Security Interventions in Ghana*

This research is part of the Agriculture Policy Support Project (APSP) to consolidate available information to support evidence-based policymaking on food security. The study is supported by USAID/Ghana under the Feed the Future Programme. The objectives of this study are to determine the levels and causes of food insecurity in households with similar characteristics, the causes of food insecurity situations observed in male and female headed households, the effectiveness of the interventions applied and their impact over time, and the gaps that need to be filled. At the end of the study, a document will be provided to inform food security policy framework in Ghana.

## *The Utilisation of Palm Kernel Oil Residue (PKOR) as Feed Ingredient for Poultry and Pigs*

This project is intended to improve the livelihood of resource poor palm kernel oil producers who are mostly women. It is also aimed at finding an alternative source of feed for livestock using non-conventional feed stuff in Ghana. This project is a department-funded project which started in 2012 and still on-going. The objective of this research is to find an alternative cheap source of feed from residue from palm kernel oil processing which hitherto was thrown away as a waste. Feeding trials of the palm kernel cake has been done on broilers and layers with tremendous success. Amino acid profile of the cake has been done and with interesting results. Feeding trials using other livestock species are on-going. Currently the School of Agriculture Teaching and Research Farm is using feed formulated with the palm kernel oil residue to feed both the chicken and the pigs. A staff member currently pursuing a PhD programme at KNUST is involved in feeding trials, using pigs. At the end of the project, the department is hoping that a cheaper source of feed ingredient would be found to replace fish meal and soyabean which are very expensive and difficult to obtain. Again, women who are involved in palm kernel processing will find an alternative livelihood through the sale of the hitherto residue.



*Palm kernel cake to be used as feed*



*Broiler chicks feeding on palm kernel cake diet*

## *Building the Capacity of Pig and Grasscutter Farmers*

The Department was also involved in COTVET/SDF-funded project aimed at building the capacity of pig and grasscutter farmers in Nzema Maale and Assin Amoaben respectively for improved livestock production. The training was aimed at building the capacity of the farmers in the areas of feeding, breeding, housing, health management, marketing, and meat processing and value addition. This was a Skills Development Fund project which supports smallholder farmers and community-based organisations to increase their production and ultimately increase their income and improve their livelihood. About 30 farmers from each of the two farmer groups were trained by resource persons from the department. At the end of the training programme, the farmers' capacity had been enhanced and their livelihood improved.





*Grasscutter reared under captivity*



*Pigs raised at the School farm*

### *Incorporation of Heat-tolerant Genes in Exotic Layers for Increased Egg Production under Heat-stress Environments*

High temperature, especially when coupled with high humidity, will cause severe stress on birds leading to reduced performance. There is therefore the need to develop strains that can tolerate the heat stress. Again, because the tropical environment is generally characterised by such stress factors like excessive heat, poor nutrition, poor housing and disease, there is therefore the need to develop breeds/strains that can tolerate a stressful environment and give acceptable level of production. It is against this background that Dr. Julius K. Hagan of the Department of Animal Science, UCC, in collaboration with Dr. K. Adomako and Dr. O. S. Olympio of the Department of Animal Science of the KNUST and Akate Farms and Trading Company, are developing a special breed of layers with heat-tolerant genes for climate change resilience. The research is aimed at incorporating heat-tolerant genes into exotic layers to make them adaptable and more productive under hot and humid Ghanaian environments. The research started in 2009 and was part of a PhD work. It is currently at an advanced stage with tremendous

progress and successes. The breeds with the heat-tolerant genes have been developed and their egg production performances are being studied. This project is partly funded by Akate Farms and Trading Company limited, which provides the material and financial resources, while the two Departments are providing the technical expertise. The expected outcome of the project is the development of highly productive and heat-stress tolerant layers that could withstand the warm and humid conditions in the tropics in this era of climate change. The impact of the research would be reduced importation or reliance of imported layers whose performance is suppressed by the high and humid environment in the tropics. The project has won me two international awards.



*Layers feeding on palm Kernel diet*



## *Incidence of viral diseases of okra in the Central Region and Identifying resistant varieties*

Okra is an important vegetable which provides an important source of vitamins, calcium, potassium, iron and other mineral matter which are lacking in the diet of developing countries. It is a source of income for rural smallholder farmers and retailers in urban centres. It is also an important non-traditional export crop. Okra Mosaic Disease (OMD) and okra leaf curl disease (OLCD) are major constraints to okra production in Ghana.



*Okra plants showing okra leaf curl disease*



*okra mosaic disease*

## *Development of appropriate strategies for the management of Taro Leaf Blight Disease in the Eastern Region*

The project seeks to improve the productivity of taro in the Eastern Region by developing management strategies that would reduce the prevalence of the Taro Leaf Blight Disease (TLBD) with the view that successful strategies may be implemented in other taro-growing regions in Ghana to ensure food security and reduce poverty.

The TLBD, caused by the fungal-like *Phytophthora colocasiae*, is a devastating disease of Taro (*Colocasia esculenta*). The disease is responsible for major field losses globally. Conditions under which taro is currently cultivated (water logged) is also conducive for the growth and development of the causal agent and the spread of the disease.

Management strategies being evaluated include rouging, spacing (planting density studies), evaluation of both local and introduced taro plants for resistance, fungicides for application and intercropping. Currently the disease is widespread and survey conducted in the region, indicates that some farmers have abandoned taro production. It is therefore imperative that strategies are found to manage the disease to ensure the livelihood of farmers and to increase production.



*Established taro fields in the Eastern region*



### *Development of Appropriate Strategies for the Management of Maize Streak Disease in the Volta Region*

Maize is a principal food and cash crop for over 100 million people in Africa. Maize streak virus disease is a major constraint to maize production in the Volta region of Ghana, which is affecting food security and farmers' livelihood in the region. The purpose of this study is to increase maize productivity through effective management of the maize streak disease. This is a 3-year project which started in 2014 and expected to end in 2017.

Expected outputs of the projects are:

- Maize cultivar resistant to maize streak disease would be identified;
- Soil amendments and tillage practices required to manage the disease would be identified;
- Farmers capacity in the management of maize streak disease would be strengthened;
- Training guide on effective management of the maize streak disease would be developed.



*Streak infected maize cob and a healthy one*



### *Green Cohesive Agricultural Resource Management*

Water, Energy-from-Biomass, Soil, Organics, and Crop (WEBSOC) is intended to intensify agriculture to create jobs in poor rural areas to promote growth and employment through research on green agricultural management strategies in Ghana, as present agricultural development depends on deforestation and show little or no increase in productivity per unit of land. The project will investigate the use of crop residues to produce biochar and wood gas for household-use to lessen the pressure on forests for firewood and charcoal as an intelligent way of recycling organics and reducing CO<sub>2</sub> emission. The application of biochar to agricultural fields increases carbon sequestration into the soil and thereby represents a CO<sub>2</sub>-negative approach to sustainably increase soil fertility, crop yields, and carbon storage. Further intensification will be achieved by small-scale solar drip fertigation systems, allowing one to two more growing seasons per year to produce high-value horticultural crops. This is a triple-win situation where farmers get sustained higher yields (from irrigation and improved soil fertility), CO<sub>2</sub> gas emissions are reduced (from increased carbon sequestration), and households get energy (from pyrolysis of straw). The Department of Crop Science, as part of her capacity building programme, will train one PhD student in the production of high value horticultural crops in the major, minor and dry seasons to ensure the continuous supply of horticultural crops in Ghana.





*Maize seedlings on WEBSOC plots*



*5 weeks after germination*

### *Development of CMD Resistant Cassava Varieties with High Beta-carotene and High Root Yield*

Cassava (*Manihot esculenta* Crantz) is the staple food for more than 800 poor people in the tropic and subtropics. The yield potential has not been fully realised since most of the cassava cultivars grown are susceptible to pests and diseases, low yielding and late bulking. The unacceptable high levels of preventable human diseases caused by malnutrition has prompted breeders to breed for increased level of micronutrients in staple crops. In view of these, seven cassava genotypes were developed through mutational breeding through collaborative work between UCC and BNARI. The breeding objectives were to increase yield, beta-carotene and resistance to common cassava diseases. Detailed

laboratory analysis has been done on these cassava genotypes on starch yield and quality, dry matter content and beta-carotene content. The seven genotypes with two released varieties as checks have been established in five environments to study the stability across locations. Prior to the release of these cassava lines to farmers as varieties, farmers field trials will be conducted in about 70 farmers' fields across the major cassava growing areas in the country.

### *Pesticide Use Practices and Perceptions of Vegetable Farmers in the Cocoa Belts of the Ashanti and Western Regions of Ghana*

Chemical pesticides are commonly used in the management of pests and diseases in vegetable production in Ghana. However, there is increasing concern about the adverse effects this use has on public health and the environment. A study was conducted to assess how much farmers know about the safe handling and use of pesticides, and what they perceive to be the hazards around their use. In-depth field surveys were undertaken with 437 sampled vegetable producers and complimented with focus group discussions and field observation.

### *Training of Peace and Love Vegetable Growers Association in Modern Agronomic Practices, Safe User of Pesticides, Hygienic Practices and Basic Principles of Marketing Vegetables*

Members of Peace and Love Vegetables Growers Association (PLVGA) were trained in modern agronomic practices to acquire skills in site selection, bed preparation, nursery practices, transplanting, pest and diseases control, field sanitation and post-harvest management. Members also acquired skills in produce packaging, pricing and marketing in addition to group dynamics to strengthen the group.



*A participant harvesting lettuce and another watering transplants*



*sieving garden soil for sterilisation*

### *Training of Assin Nyame Bekyere Oil Palm Processing Association and Assin Dawumako Nyameyie Co-operative Farmers Society in Modern and Innovative Agronomic Practices for Increased Productivity in Oil Palm Cultivation*

This project trained members of the two groups to acquire skills in modern oil palm nursery practices, innovative ways of transplanting and controlling pests, diseases and weeds and irrigating transplants. The farmers were trained and directed to the appropriate sources of agro inputs such as pre germinated seeds, fertilizers and pesticides. Farmers acquired skills in nursery practices and have started producing their own improved seedlings.

### *Training of Pineapple Farmers in 10 Communities of Ekumfi in Appropriate Practices in Organic Pineapple Production*

Pineapple farmers from the 10 communities of Ekumfi were trained on methods of land preparation, planting practices, soil fertility management, and pest and disease control in organic pineapple production.

### *Utilisation of Sweet Potato (*Ipomea batatas*) in Composite Flour Production*

Vitamin A deficiency is a global problem especially in under developed and developing countries in Africa and Asia. Ghana is reported to have 75% of the 6-59 months being vitamin A deficient even though there is the annual programme of provision vitamin A supplement (VAS) to this age group. Furthermore, these measures are targeted at children under five, whereas the problem of vitamin A deficiency is not exclusive to this age group only. Besides, supplementation is only one of several approaches to address the issue of nutrient deficiency and therefore additional strategies such as food fortification and diversification of diet can also be adopted as long-term measures. The objective was to find out the sweet potato-maize flour formulation that has the best nutritional qualities in terms of protein and beta-carotene and subsequently use this in clinical studies.



*Participants listening to a resource person*

Maize-sweet potato (MSP) composite flour with substantial protein and ***β-carotene***, a pro-vitamin A carotenoid, was used in feeding trials among 357 primary 1 to 3 pupils in three public schools in the Cape Coast Metropolis in Central region of Ghana. Baseline tests and tests after the feeding trials indicated that the MSP flour was effective in increasing the retinol binding protein (RBP), a surrogate



of serum retinol, levels of the respondents. There were increases in anthropometric indices such as weight-for-age and height-for-age. Severe to moderate underweight decreased from after the feeding trial. Similarly, the retinol binding protein above the upper limit of the National Health and Nutrition Examination Survey (NHANES) cut-off was increased by 30%.

Essentially, the results of the study showed that prepared food from maize-sweet potato (MSP) composite flour could be one way to address vitamin A deficiency among infants aged 6 - 59 months. The study could be replicated in other regions of Ghana to gather data that could be used to establish national cut-offs for vitamin A in the population (this is currently not available), and also to find the efficacy of the use of MSP in national programmes addressing vitamin A



Measuring the height of a pupil

### Assessing the potential of *Dioscorea praehensilis* (Bush yam) as a commercial and food security crop in Ghana.

Whilst there is great diversity in *Dioscorea praehensilis* to be exploited for crop improvement, the production of this underutilized yam also has several advantages over the known commercial species of yam. *Dioscorea praehensilis* has however been neglected and is only grown on a small scale. One of the reasons attributable to the non-popularity of *D. praehensilis* is its short post-harvest shelf life. The project therefore seeks to create baseline knowledge on the spatial distribution, diversity and morphological characteristics, and variations in shelf life of *D. praehensilis* to support scientific exploitation and production as a commercial and food security

crop. The socio-economic assessment of the production of *D. praehensilis* and its implications for commercialization in Ghana will also be conducted. The aims to: (i) collect and characterize the diversity of germplasm for *D. praehensilis* in Ghana; (ii) document indigenous knowledge on *D. praehensilis*; (iii) select cultivars with superior tuber shelf life and preferable cooking qualities for introduction to farmers and other stakeholders in the yam value chain; (iv) investigate suitable methods for field establishment and rapid multiplication of planting materials of selected cultivars and (v) assess consumer preference for selected cultivars of *D. praehensilis*. The project will be accomplished through five major activities: (a) Germplasm collection from major production zones of *D. praehensilis* in Ghana; (b) Documentation of indigenous knowledge; (c) Field screening and characterization of collected accessions; (d) Culinary assessment; (e) Planting material multiplication, profitability analysis and consumer preference survey for *D. praehensilis*.



Feeding session in one of the schools where the intervention was implemented



Samples of *D. praehensilis* germplasm collected



*Field establishment of D. praehensilis at the UCC Teaching and Research Farm.*

### *Influence of Thermal Processing on The Nutrient Content and Shelf-life of Soursop Juice*

Soursop is a nutritious, but under-utilised fruit, which can be consumed fresh or in the processed form. One of the reasons accounting for its under-utilisation is the short shelf-life of the fruit after harvest. Processing of the fruit into juice can provide a means of extending the usage of the soursop. Processing, however, can lead to changes in the nutritional composition of the juice. This study is investigating the effect of processing on the nutritional content of soursop juice. The main objective will be to determine the effect of heat processing on the nutritional content of soursop juice treated at different temperatures and for different times. Additionally, the shelf-life of the processed juice would be investigated. At the end of this project, it is hoped that processing conditions will be obtained that can extend the shelf-life of soursop juice with a minimal effect on nutritional content. This information can be utilised by food processors to design optimal conditions for processing soursop juice. Taking into account that soursop can be intercropped with other crops, an increase in usage of the fruit can lead to extra income for farmers.

### *Birds, Bees and Butter Project – Enhancing Ecosystem Services in the Shea Parklands of sub-Sahara Africa (Ghana and Burkina Faso)*

Shea trees are not only the source of the famous moisturising butter but also provide vital food and income for approximately 80 million people in sub-Saharan Africa. Once part of a diverse parkland habitat, shea is now one of the few species retained in these agricultural landscapes as other trees are removed for fuelwood and charcoal and to make way for crops and livestock.

Many species of bird that migrate through the shea zone in Africa are showing dramatic population declines in their European breeding ranges (e.g. the Willow Warbler, Pied Flycatcher and Tree Pipit). Research commissioned by a partnership of BirdLife International, Netherlands–Society for the Protection of Birds (VBN) and UK–Royal Society for the Protection of Birds (RSPB) has found a potential link between these migrant declines and the lack of suitable habitat in shea-growing regions. Moreover, worldwide, the loss of habitat diversity has been linked to declines in insect pollinators. Although there is very little knowledge about shea pollination, experts have a hunch that the parkland monocultures may not be “bee-friendly”, contributing to lower shea yields.

BirdLife has commissioned a research project led by Jane Stout (University College of Dublin), Peter Kwapong (International Stingless Bee Centre) and Issa Nombé (University of Ouagadougou), and supported by its partners Ghana Wildlife Society and Naturama, to discover the role insects play in shea production. Recently the team spent some time in the parklands of northern Ghana and southern Burkina Faso setting up experiments to find out whether production of shea is being limited by the number of insect pollinators.



*Cattle grazing on the shea parklands*

## **Black Soldier Fly as Engineers for Municipal Waste Management, Compost Production and as Food for Fish**

Ghana is plagued with solid waste management problems. This initiative is part of a Swiss funded project and has the broad aim of producing industrial compost from municipal solid waste. The resulting compost could be used in organic farming and the larvae could be processed into feed for fish and poultry. This is anticipated to generate employment, increase agricultural productivity, reduce poverty and contribute indirectly to food security in Ghana.

Accessible literature shows that some amount of solid waste is not collected and as a result ends up in open spaces and drains leading to flooding, water pollution, spread of diseases, and ugly sights of stinking and pest-infested piles of solid waste in some parts of urban areas. Urban and peri-urban agriculture systems face the problem of low productivity due to inappropriate soil fertility management strategies. Compost production is gaining recognition among the youth, governmental and private organisations due to its high organic matter and appreciable amounts of macro-and micro-nutrients, but the composting process lasts long (3-4 months) affecting the cost of production and the quality (nitrogen content). This has resulted in a low patronage of the technology and the use of the compost product in crop production. Fish is the principal source of protein for Ghanaians. Consequently, aquaculture production in Ghana has been increasing in recent times. The aquaculture farming is however constrained by high feed cost leading to a significant shortfall in national fish production. The black soldier fly, *Hermetia illucens* (L.) (Diptera: Stratiomyidae) occurs worldwide in the tropical and warmer temperate regions between about 45°N and 40°S. Using black soldier fly larvae to biodegrade organic fraction of municipal waste could be a paradigm shift in waste management in Ghana, reducing cost and end up producing high quality compost for soil improvement and food production. Additionally, the larvae are composed of 35 - 44% crude protein, 33 - 35% fat and contain essential amino acids indicating its suitability as fish and animal feed component. Rearing of *H. illucens* has been concentrated in the temperate zones by companies on a relatively small scale. In Ghana, only a few researches have been done on both rearing and using *H. illucens* in waste management. To achieve the optimum benefit, there is thus the need to establish and maintain a stable wild colony stock of this insect.



*Black soldier fly*



*Larvae of Black soldier fly*

## **Valorisation of Green Agriculture in Africa (Ghana, Kenya Tanzania and Denmark – DANIDA Project)**

Two projects focus on green growth. One of them will create new knowledge on how African 'Origin Product' producers can add value to their products by documenting and incorporating territory specific cultural, environmental and social qualities and will, thus, promote wise use of market forces.

Africa has untapped potential for creating monetary value from origin products in the same way ham from Parma and other highly valuable EU agricultural origin food products registered with 'protected' Geographical Indications (GIs) add 15 billion Euros per annum to European agriculture. Aiming to accelerate valorisation of green inclusive growth in Africa, Valorising Green Growth in Africa (VALOR) will create new knowledge on how African Origin Product (OP) producers can add value to their products by documenting and incorporating territory specific cultural, environmental and social qualities. In the Comprehensive Africa Agriculture Development Programme (CAADP) context, VALOR will thus promote wise use of market forces. VALOR involves research capacity strengthening in three partner countries, Ghana, Kenya and Tanzania, pursuing its objectives via five work packages (WPs). WP1 investigates institutional environments for valorisation via OPs & GIs, WP2 collects and analyses data on private sector practices with OPs and GIs, and WP3 provides an in-depth strategic case study of honey as a GI product embodying the smallholder stewarded ecosystem service pollination.



WP4 provides crosscutting analysis and synthesise research findings for policy relevance while WP5 coordinates the project, including the research capacity building activities through the WPs. Six PhD students, 5 universities & knowledge dissemination. Project methodology ensures data collection and fieldwork, involving agencies in the public and private sector. Articles, conference papers, policy briefs, website & other VALOR outputs feed into an impact pathway including country roundtables & review mechanisms of the CAADP, helping Africa leapfrog into a green economy allowing geographical indications (GI's) add billions of Euros to its monetary economy and allowing smallholders create employment and build monetary value, stewarding pollination services, and so increasing qualities and volumes of the wider food economy

### ***Global Pollination Project (GPP): Conservation and Management of Pollinators for Sustainable Agriculture through an Ecosystem Approach***

Previous crop pollination failures have brought sustainable pollination issues to the fore. With managed honeybee populations rapidly declining and more crops being grown under intensive systems, there is good reason to identify, in multiple agroecosystems and ecologies, the practices that prevent the loss of pollination services. Unfortunately, the level of capacity to manage pollination services, and the public awareness of their importance is very low, both in traditional and modern societies.

In response to these challenges, the "Conservation and Management of Pollinators for Sustainable Agriculture: Through an Ecosystem Approach" (also known as the Global Pollination Project - GPP) was developed -funded by the Global Environment Facility (GEF) and coordinated by FAO with implementation support from the United Nations Environment Programme (UNEP).

The development objective of the project was improved food security, nutrition and livelihoods through enhanced conservation and sustainable use of pollinators. The immediate objective was to harness the benefits of pollination services provided by wild biodiversity for human livelihoods and sustainable agriculture, through an ecosystem approach in seven selected countries (Brazil, Ghana, Kenya, South Africa, Pakistan, India and Nepal).

The project outcomes have been:

- a consolidated knowledge base, integrating traditional and scientific knowledge established.
- best agricultural practices for pollinator conservation and

sustainable use identified, tested, implemented, documented and promoted.

- enhanced capacity for conservation and sustainable use of pollinators developed.
- awareness of conservation and sustainable use of pollinators for the general public and for policymakers enhanced.

The project showed how the services of pollination can be conserved and used sustainably in agriculture through the application of the ecosystem approach. Project outcomes were tested, evaluated, and showcased in a set of representative farming systems in seven countries with a wide diversity of ecological zones and farming patterns. Each country established Study, Training, Evaluation, and Promotion (STEP) sites, where field activities were undertaken together with farmers. Through the development of best agricultural practices for pollination services, and building on an extended knowledge base, capacity was increased and awareness raised to promote wise management of pollinators and their services.

At the global level, the GPP partnered with a number of highly-respected institutions and experts to develop tools and guidance material on a range of pollinator and pollination-related issues. In other instances, guidance materials were prepared with inputs from GPP partner countries. As a result of project efforts, a set of tools, methodologies, strategies, and best management practices were produced that can be applied to pollinator conservation efforts worldwide.

### ***Global Thematic Assessment of Pollinators, Pollination and Food Production by the Intergovernmental Science- Platform and Ecosystem Services (IPBES)***

The Intergovernmental Science-Policy Platform on Biodiversity and Ecosystem Services (IPBES) was established in April 2012, as an independent intergovernmental body for assessing the state of the planet's biodiversity, its ecosystems and the essential services they provide to society. IPBES is open to all Member States of the United Nations and currently has 124 members.

IPBES assessments provide policymakers with scientifically credible and independent information to make informed decisions about how to protect biodiversity and ecosystem services. The assessments also put forth methods to interpret the findings and reflect the complex relationships between biodiversity, ecosystem services, and people.



IPBES assessments are conducted by leading experts who synthesize, review, assess, and critically evaluate relevant information and knowledge generated worldwide by governments, academia, scientific organisations, non-governmental organisations, and indigenous and local communities. Currently, there are about 1000 IPBES experts and these were selected based on nominations from governments and interested organisations around the world.

The work of IPBES is supported by a Secretariat based in Bonn, Germany. It operates under the auspices of four United Nations programmes/organisations:

- United Nations Environmental Programme (UNEP);
- United Nations Educational, Scientific and Cultural Organisation (UNESCO);
- Food and Agriculture Organisation of the United Nations (FAO) and
- United Nations Development Programme (UNDP).



*A – Peedy grady chamber used to evaluate efficacy of mosquito coil against mosquitoes*



*B – World Health Organisation insecticide susceptibility kit used for measuring insecticide resistance status of mosquitoes*

## *Monitoring Insecticide Resistance in Anopheles, Culex and Aedes Mosquitoes and their Impact on Mosquito Control Strategies used at the Household Level*

This project by Dr. Andreas A Kudom of the Department of Conservation Biology and Entomology has two objectives which are:

1. determining insecticide resistance status of Anopheles, Culex and Aedes mosquitoes in Southern Ghana.
2. evaluating efficacy of insecticide bed net and mosquito coils against local mosquitoes in southern Ghana.

The project, which is currently on-going, could uncover knowledge that could help in policy formulation on the use of insecticide at the household level. It would also offer recommendations on best practices in the use of insecticide at the household level for optimal benefits. Two tools essential in carrying out the research are a peedy grady and World Health organisation insecticide monitoring tool.

## *Evaluation of Efficacy of Aqueous Neem Leaf Extract against Pyrethroid-resistant Anopheles Larvae*

Pyrethroid is the active component in many of the insecticides that could be obtained from the shelf. It was developed after World War II to replace the more natural insecticide pyrethrin that preceded it but was found to lose activity within hours or minutes after application, especially when exposed to air. Various forms of the pyrethroid have been developed, especially in the 1960's. These have been used to fight insects, including mosquitoes. However some mosquito life cycle stages have developed resistance to this insecticide. An example is the Anopheles larvae. This necessitated a search for a new insecticide. The current project seeks to use an aqueous extract of "neem" as a replacement for pyrethroid in fighting Anopheles larvae.

The specific tasks undertaken are:

1. Assessing efficacy of aqueous "neem" extract against pyrethroid
2. Monitoring the life history and enzyme activities of survivors that emerge as adults

The work which is currently on-going is being sponsored by The World Academy of Sciences (TWAS).



*Mosquito larvae exposed to aqueous neem extract*



*Water samples from different habitats for fluorescence analysis*

### *Characterisation of Organic Pollution in Mosquito Breeding Sites using Fluorescence Spectroscopy*

The objective of this study was to determine dissolved organic matter (DOM) in different mosquito habitats. This project is under the auspices of Laser and Fibre Optics (LAFOC), Department of Physics with Dr. Baah Sefa-Ntiri as the main collaborator.



*Dr. Kudom at work in a mosquito breeding site*



*Two mosquito breeding habitats with different level of water quality*

## *A Survey of Mosquito Fauna and Assessment on Knowledge of Mosquito Life History among Inhabitants of Cape Coast, Ghana*

Malaria control and prevention are based on multi-pronged approaches involving physical, chemical, and cultural control methods for restricting mosquito breeding. Previous studies have focused little attention on residents' knowledge of the life history of mosquito and how this knowledge may potentially inform mosquito control practices within neighbourhoods in urbanized areas. This research, which was funded by the British Ecological Society, addressed a gap, both in understanding the degree to which "neighbourhood" mosquito breeding has the potential to contribute to local mosquito problems, and in assessing what residents "think and do" about mosquito control within their home environment.



## *Jimi Dam Sediment Profile Study, AngloGold Ashanti Limited (Obuasi Mine)*

This study was carried out in response to AngloGold Ashanti Limited Obuasi Mine's intention to dredge the Jimi Dam at Jimi Kakraba in order to solve the problem of sedimentation and increase the water holding capacity of the dam. The study was to give an indication of the quality of the sediment that will be very essential in aid of the dredging process. Sediment cores were collected up to a depth of 60 cm deep using a mechanical sediment corer lowered from a motorised canoe. The corer had a length of 60 cm with a diameter of 8 cm. Contamination factors and degree of contamination were calculated for both metals and sampling locations. In addition, the general characteristics of sediments, including the textural classes were also determined. Interpolation maps of selected trace metals were also produced.



*Launching boat onto the dam*



*Safety induction*





*Driving the corer into the dambed*



*Assembling the corer*



*Corer filled with sediment*

## *Pit Water Profiling and Quality Assessment of the Block 7/8 Pit, Block 3 Valley, Teberebei and UEE Dams of AngloGold Ashanti Iduapriem Ltd*

This study involved the profile sampling and water quality analysis of the Block 7/8 pit, Block 3 Valley, Teberebei and UEE Dams of AngloGold Ashanti Iduapriem Limited (AAIL), Tarkwa, a subsidiary of Anglo Gold Ashanti Pty (Ltd).

The study aided in assessing the current state of water quality in these water holding-facilities, with respect to metal concentration levels and physicochemical parameters, with the intention of providing important information as to the suitability of discharge or otherwise. The research concluded that the quality of water in the various water-holding facilities at the time of study met the discharge standards as set by the Ghana Environmental Protection Agency.



*Launching of dingy onto the Block 7/8 Pit*



*Taking physicochemical readings*



*The Team preparing the sample the UEE dam*



## *Bathymetric study of the Sibi North (Gyabunso) Open Pit, AngloGold Ashanti Ltd., Obuasi*

The bathymetric study involved profile sampling and water quality analysis of the pit to aid in assessing the current state of water quality with respect to metal concentration levels and physicochemical parameters, with the intention of providing important information to aid the discharge of the pit water for subsequent re-filling of the pit. Again, the bottom contours and the volume of water contained in the pit were determined to aid in calculating an appropriate pumping rate that will prevent flooding along the corridor of the receiving medium. The study concluded that the quality of water in the Gyabunso pit, which was slightly higher than the receiving medium, satisfies the EPA requirements for discharge. Therefore, dewatering the pit into the receiving media does not pose a risk to the ecological system. At the time of the study, the volume of water in the pit was determined to be 2,530,800 m<sup>3</sup> and the maximum depth sampled was 105 m. The recommended discharge rate was determined to be 0.32 m<sup>3</sup>/sec or 320 litres/sec in conformity with the flow rate of the receiving media and will take 3 months to completely pump out the water from the pit.



*Snapshots of the Team undertaking bathymetric studies in the UEE dam*



## *Sediment and Surface Water Quality Monitoring of Streams in the Catchment of Edikan Gold Mine (EGM), formerly the Central Ashanti Gold Limited (CAGL, Ayanfuri)*

This is an on-going half-yearly monitoring programme, which started in 2011. The project was initiated as part of the company's baseline water and sediment study of all streams within the catchment area. It was then instituted as a monitoring programme to provide data on the metal concentration levels and physicochemical parameters since the start of mining operations, with the mandate of providing important information on the impact of these activities on the water bodies and also meeting the reporting requirements as part of their environmental management schedules.



## *Groundwater Studies around the South and East Tailings Storage Facilities (TSFs) of Goldfields Ghana Ltd, Darmang Mine*

This study involved assessing the pH of ground water and seepages around the Tailings Storage Facilities (TSFs) and determining the causal factors of the low pH regimes within the project area. The project was carried out within the immediate vicinities of the TSFs and adjoining communities where ground water drainage is in line with the TSFs. The aims were to:

1. review historic and current ground water data.
2. establish the factors contributing to the low pH of ground water around TSFs.
3. ascertain whether or not the tailings material on the TSFs have impacted on ground water pH.
4. determine a correlation between soil geology and ground water pH.
5. Identify whether the composition of TSF seepages as named by AGL include some ground water.

The study concluded that the low pH experienced in the ground waters around the South tailings dam and other locations are geogenic (natural), thus the factors contributing to the low pH of groundwater around the TSFs are geologically related. Also, soil geology and ground water pH were very positively correlated and the ground water had not been impacted negatively by the tailings material. The potential for Acid Mine Drainage (AMD) was significantly low.





## *Bathymetric Survey and Water Volume Estimation for the Tailings Storage Facility 2, Obra and Sariuhu Pits of Kinross Chirano Gold Mine, Ghana*

The study involved performing a bathymetric survey using echo sounding techniques and analysis aimed at estimating the volume of water in the TSF2, Sariuhu and Obra pits. It entailed the survey of the sub-aqueous contours of the TSF2, Sariuhu and Obra Pits using echo sounding techniques, numerically modelling the bathymetry to generate pond curves for TSF2, Sariuhu and Obra Ponds (that can be used to predict dam water volume and water surface area from water surface elevation) and survey mapping the bathymetry data. The project lasted for two months.



*Snapshots of bathymetric survey of a tailings storage pit at the Chirano Gold Mine*

## *Profile Sampling, Water and Sediment Quality Assessment of Water Bodies at Kinross Chirano Gold Mine, Ghana*

The study involved undertaking bathymetric assessments, water and sediment quality analysis as well as profile sampling of pits and other water containment facilities within the area of influence of the Mine. Specifically, it entailed conducting profile sampling of water bodies - Suraw Pond, Water Storage Facility, Sumps near Toes of Waste Rock dumps, Sumps at Underground, Water Containment/Storage Facility at Akwaaba, Obra and Sariuhu pits. The study was done to determine the water quantities and quality at different depths and locations. Again, water and sediment quality analysis for the Suraw and Mamnao rivers were carried out. The project lasted for six weeks.





*Snapshots of field studies at the Chirano Gold Mine*



*Snapshots of field studies at the Chirano Gold Mine*



## *Dredging of Ntakofam River under the Local Climate Change Adaptive Living (Local) Project for Dry Season Vegetable Production at Effutu Municipal Assembly, Winneba- Central Region*

The Effutu Municipal Assembly wanted to promote agriculture as a lead employment generation to reduce unemployment among the youth. The Assembly therefore decided to develop the Ntakofam River for dry season vegetable production with support of Canadian International Development Agency (CIDA). The Ntakofam River was deepened and widened by excavating along the longitudinal section of the channel and disposing the material away. The depth of excavation was between 1.5 metres and 2 metres, and the width was about 30 m. The length of the river covered was about 2km. The excavation covered a surface area of 95,306 m<sup>2</sup> resulting in a total storage volume of 143,000 m<sup>3</sup>. This volume was enough to irrigate about 50 hectares in the dry season for vegetable cultivation.



*Dr. Takase having discussion with section of the farmers and Municipal coordinating Council*



*Work begins as bulldozer starts clearing the place*





*Excavator at work and consultant inspecting the work of the excavator*



*Plate 5: Dredged Ntakofam River at completion*

UCC is located close to the ocean making the Department of Fisheries and Aquatic Sciences (DFAS) one of the leading institutions in the area of Fisheries and Marine Sciences in Ghana. Indeed, the Department since its inception in 2002, had the vision to become unique and an innovative partner in advancing healthy aquatic ecosystems for sustained provision of goods and services, in collaboration with public and private institutions, both local and internationally.



*Snapshot of faculty, staff and students of the Department of Fisheries and Aquatic Sciences*

This vision is beginning to see the light of the day through the USAID multi-year funding to the tune of US\$ 5.5 million. Through this grant, the capacity of the Department to deliver this vision is enhanced through the provision of adequate logistics and teaching infrastructure, increasing student numbers largely due to new knowledge about the capacity of the Department, possible job opportunities, enhanced sensitisation about the Department and deepening relationships with related institutions. With this project coming on board, a lot of issues have been largely addressed. The USAID funds has enabled the Centre for Coastal Management effectively take off its operations and received formal institutional recognition.

Through this grant, the Department now has state-of-the-art laboratory with relevant and modern laboratory and field equipment procured and soon to be installed to allow hands-on practical based training of students.

The Department offers undergraduate (BSc.) degree in Fisheries and Aquatic Sciences and postgraduate (MPhil and PhD) degrees that expose students to:

- Oceanography, Limnology and Aquatic Ecology
- Integrated Coastal Resource Management including Petroleum Ecology and Climate Change Studies
- Aquaculture, bridging gaps between demand and supply in the fishing industry and aquaculture entrepreneurship
- Fisheries Science including fisheries ecology and organismic interactions.

With the USAID grant, several opportunities abound. This includes:

- i. Funding for undergraduate project work in the final year is guaranteed under the multi-year USAID/UCC Fisheries and Coastal Management Capacity Building Support Project (2014-2019).
- ii. Students could benefit from the J-TERM Student Exchange Programme with the University of Rhode Island in the United States of America.

iii. Undergraduate grants and postgraduate scholarships – The Department offers grants and limited scholarship opportunities towards MPhil and PhD study programmes in the fields of Integrated Coastal Zone Management, Aquaculture, Fisheries Science, Oceanography, and Limnology. This presents our undergraduate students with future academic prospects.

Staff and students also benefit from interactive teaching and learning alongside field visits and real-time laboratory exposure in and outside Ghana for practical experience.



*Faculty and collaborators at the Department of Fisheries and Aquatic Sciences*

It is anticipated that graduates could engage in research work in Institutions (including CSIR, Water Resources Commission), Ministries (Fisheries and Aquaculture Development; Environment, Science and Technology; Agriculture), Environmental sector, Financial institutions, Oil and Gas industry, NGOs (local and international), Managers of Aquaculture Facilities, Navy, Academia, or become Entrepreneurs among others.



### *The USAID/ UCC Fisheries and Coastal Management Capacity Building Support Project*

This project has an institutional focus on the University of Cape Coast/Department of Fisheries and Aquatic Sciences (UCC/DFAS) and its newly formed Centre for Coastal Management (CCM). The project will strengthen UCC/ DFAS/CCM as a centre of excellence in fisheries management, CRM and adaptation to climate change in coastal zones.



It is aimed at strengthening DFAS programmes of higher education and training, strengthening relevant research networks and building the capacity of students and staff of DFAS/CCM in accessing, disseminating, and extending research findings to improve management - essentially 'extension' in coastal and marine environments. Through this project, DFAS and CCM is promoting the increased use of science and applied research to inform decision-making, law enforcement, and the implementation of management plans.

The project is improving the management of marine resources to reduce over-exploitation, conserve biodiversity, and provide other livelihood benefits to inhabitants along the coast.

Key partners include the Ministry of Fisheries and Aquaculture Development (MOFAD) and the Fisheries Commission of Ghana, USAID Sustainable Fisheries Management Project under the auspices of Coastal Resources Center (CRC) of the University of Rhode Island, Coastal Sustainable Landscapes Project under the auspices of the US Forest Service, and all coastal districts particularly in the Central and Western Regions of Ghana.

To support teaching, research and extension activities of the department, the project procured three vehicles - a 4X4 cross-country vehicle, one 4X4 multi-purpose pick-up truck and a bus plus one research boat named RV Sardinella for coastal environmental assessments.

The vessel has been approved for use by the Ministry for Fisheries and Aquaculture Development (MoFAD).

## FishCoM Ghana - Interactive web interface on fisheries and coastal management in Ghana

The primary goal of FishCoM Ghana database is to provide a common point of reference for information on Ghana's fisheries and coastal resources and their supporting ecosystems for all stakeholders. The database is a comprehensive web-based repository that seeks to collate, manage and distribute data (both published and unpublished) and other relevant information through the internet to support fisheries and coastal resource management and research in Ghana. It is an initiative of the Department of Fisheries and Aquatic Sciences and the Centre for Coastal Management (CCM) of the University of Cape Coast with support from the United States Agency for International Development USAID. FishCoM Ghana contains data on inland, marine and coastal resources of Ghana. The data are provided by scientists and others working on Ghana's aquatic resources. The University of Cape Coast is grateful for the contributions she has received from all institutions towards this Project.

**FishCoM Ghana aims to be** scientific, professional, credible, user friendly and regularly updated. Visit [fishcomghana.com](http://fishcomghana.com) to view clearer content on website: <https://fishcomghana.com/>

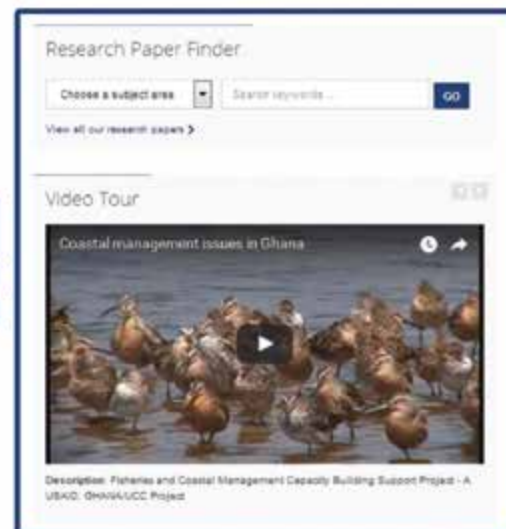
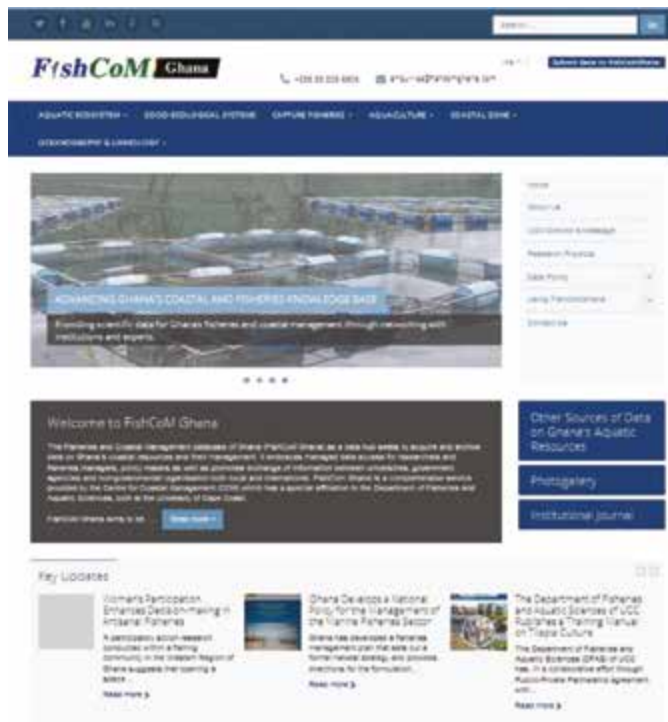





The Project also with the support of USAID has successfully launched an information management system on aquatic and coastal resources management in Ghana. Known as FishCoM Ghana, the system is a comprehensive web-based repository that seeks to harmonise as much available data as possible on fisheries and coastal issues across the country. FishCoM Ghana is web-based and can also be accessed via mobile phone on: <http://fishcomghana.com/>

The database is important because large data is a vital resource for the advancement of critical sectors. However, data on fisheries and the marine environment are scattered in the repositories of different national institutions such as CSIR, EPA, Universities and scientific survey divisions of Government Ministries (e.g., of Fisheries and Aquaculture Development).

The situation limits our capacity as a nation to effectively integrate long-term observations on our coastal habitats and resources to support the development and sustainable management of our fisheries.



*Participants at the launch of FishCoM.Ghana, an initiative of the Department of Fisheries and Aquatic Sciences, UCC*

## ***Public-Private Partnership to Establish a Fish Farming Training Centre of Excellence in Ghana***

This project has enabled an innovative public-private partnership project that allows DFAS-UCC to collaborate with Ainoo-Ansah farms to establish an Aquaculture Training Centre of Excellence in Ghana. The project will develop manuals and short-term proficiency training courses for prospective and present fish farmers in fish hatchery techniques, and aquaculture in general. The project will serve the needs of commercial and small-scale fish farmers as well as interested individuals and institutions. It has established a help-desk that provides information and technical know-how on issues related to fisheries resources management and aquaculture in Ghana. The Department collaborated with Ainoo-Ansah Farms Ltd and the Ghana Aquaculture Association for the implementation of this project.



*Fishing for Security Project*





This project identified the drivers of piracy and other unlawful maritime activities in the Gulf of Guinea region of West Africa. The project evaluated the role of subsistence, artisanal, domestic industrial and foreign industrial fisheries in promoting or jeopardising national and regional security. Cross-sectoral causes of conflict (e.g. fisheries vs. oil and gas) were also investigated. Appropriate policy options for communities, national governments and regional intergovernmental bodies, including the relevant fisheries management and maritime law enforcement agencies were identified. Key Project Partners included the Australian National Centre for Ocean Resources and Security (ANCORS), University of Wollongong and the Department of Fisheries and Marine Sciences of the University of Ghana.



*Junior High School teachers from the Western Region of Ghana being trained on wetlands ecological health and monitoring*



*Fishing for Security Project*



### *Development of Wetlands Educational Curricula for Junior and Senior High Schools in Ghana*

This project developed an educational monitoring programme for the coastal wetlands of the Western Region of Ghana involving various actors that include but are not limited to Senior and Junior Secondary Schools, local communities, regional NGOs such as Friends of the Nation, Hen Mpoano as well as the Ghana Wildlife Division. It allowed students and faculty from the Department of Fisheries and Aquatic Sciences and its counterpart Centre for Coastal Management collaborate with the CCM-UCC to strengthen their capacity for outreach/extension in the area of monitoring of the ecological health of coastal habitats. The project involved the development of participatory and a competitive monitoring programme that serves to raise awareness of the importance of wetlands, promote better governance towards conservation and restoration of wetlands, and provide an important monitoring tool for academics and policymakers.

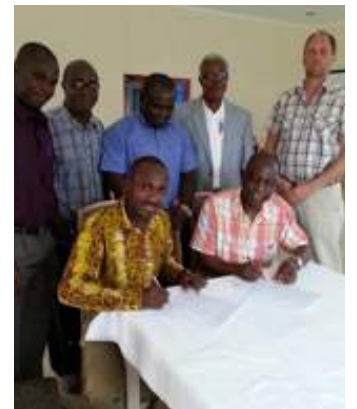



## Climate Change Adaptation Short

A short-course on climate change, with relevant contextual aspects for Ghana's coastal areas, was developed and implemented within the University of Cape Coast by DFAS. The project ensured that a well-developed short course on climate change was taught based on a needs assessment for district and regional level planners and National Disaster Management personnel. Key activities included the development of materials and training instructions for 5 days of course modules and practical exercises as well as the documentation of best practices on climate change adaptation/mitigation strategies within the African sub-region. A practical field manual on climate change vulnerability assessment was a major output with a guide for coaching participants.

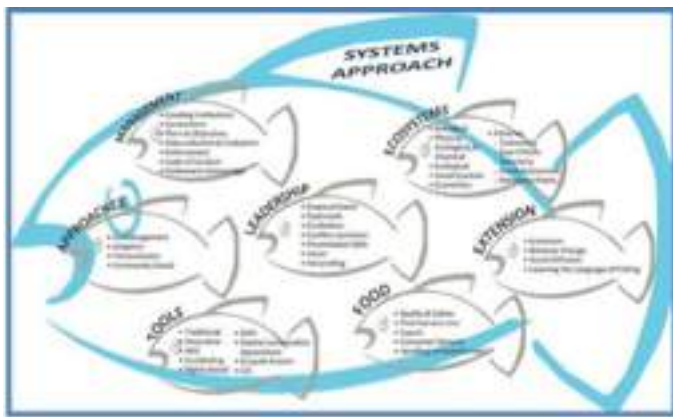

## Training in Integrated Coastal Zone Management

This training was run for the Coastal Resources Center-Ghana (CRC), a USAID funded project in the Western Region. The approach typically followed the Integrated Coastal Management (ICM) modules that have been developed and established within DFAS with particular emphasis on Ghana and relates to issues that have been suggested by CRC such as as priority topics that address their relevant needs. The approach, typically, followed a 2-day training session at Princess Town. There were presentations, posters and interactions with participants and fieldwork activities.



## Identification and Characterisation of Ghanaian Cowpea (*Vigna unguiculata* L. Walp) Accessions Resistant to the Parasitic Weed *Striga gesnerioides* using Microsatellite Markers

### a) Sustainable Utilisation of Cowpea genetic Resources for Enhanced Food Security and Poverty Alleviation in the Dry Savannah Northern Regions of Ghana

The influence of the parasitic weed, *Striga gesnerioides*, drought and low soil fertility continue to pose challenges to sustainable production of cowpea in the dry savannah of the Northern Regions, which constitute about 60% of production area in Ghana. The yield loss in cowpea due to *Striga gesnerioides* alone, ranges from 80 - 100%. This might have contributed to poverty, hunger and malnutrition, affecting 15 million resource poor farmers and children in Ghana. However, cowpea is the cheapest source of plant protein for almost every Ghanaian. Utilisation of improved *Striga*-resistant cowpea genetic resources could mitigate *Striga* and possibly drought effects, towards sustainable production of the crop to enhance food security and poverty reduction in Ghana. The main objective of the current work is to study the physical and genetic characteristics of 120 newly developed cowpea varieties and GH3684 (a variety that has been identified to be resistant to *Striga*) and to select farmer and consumer preferred *Striga*-resistant, drought-tolerant varieties after multi-location trials. This is with the view of enhancing on-farm conservation and sustainable production of the crop in the savannah ecosystems towards food security and poverty alleviation among resource-poor and small-holder farmers in Ghana.

The project which was started in 2015 and currently on-going, seeks to achieve the above objective through specific tasks which include:

1. Evaluation and multiplication of 30 cowpea genotypes on-station and on-farm in *Striga*-hotspots of Savannah Agriculture Research Institute, (Manga Station near Bawku, Upper East and Savolugu, Upper West) as well as non-*Striga* infested ecological zone of the Coastal Savannah and semi-deciduous forest.
2. Conducting comparative multi-location trials with 300 resource-poor farmers and conservation of cowpea in the *Striga* hotspots of the three northern regions, non-infested coastal savannah, and transition zone of Ghana for adaptability to pests, diseases, soil, temperature, rainfall, nitrogen-fixing and organic matter retention abilities.
3. Assessing the nutritional properties, cooking-ability and

palatability of 10 selected cowpeas, and develop protocol to release at least 6 Striga-resistant and drought-tolerant varieties for cultivation and conservation.



*Laboratory section demonstrating isolation of DNA from cowpea*



*Cowpea field in the Teaching and Research Farm-Harvesting of cowpea by Research Assistants of the School of Agriculture*

Various activities have already been carried out in connection with the current project. This includes introduction of the Striga-resistant cowpea variety to farmers in the Cape Coast Metropolis at a Farmers School and Farmers Day (FED) training at the Teaching and Research Farm of the School of Agriculture, University of Cape Coast. During the training session, the farmers were given the opportunity to select cowpeas of their choice from the improved varieties so that these could be multiplied and made available for planting in their respective farms.

### ***Effect of Sacred Grove Size and Isolation Distance on Avifaunal Assemblages in Forest-savanna Transition Zone of Ghana***

This annual grant is operationalized in collaboration with the British Trust for Ornithology, UK (BTO), A. P. Leventis Ornithological Research Institute, (APLORI) University of Jos, Nigeria and University of Cape Coast (UCC), Ghana. In this collaboration, two students are enrolled for a year MSc programme in APLORI in Nigeria specialising in Ornithology and a top-up research in UCC, Ghana for the MPhil component. The first candidate has finished

his thesis and submitted to the School of Graduate Studies for assessment and further action.

The main collaborators are Dr. Phil Atkinson from BTO, Prof. Manu from APLORI and Dr. Justus P. Deikumah from the Department of Conservation Biology and Entomology, UCC.

### ***Indigenous Vulture Monitoring Project***

The Rufford Small Grant is to help train indigenes about how to identify and monitor vultures in Ghana. The grant was approved and received in December, 2015 and the project starting in January 2016. The duration for this project was twelve months. The project is in its completion stage. The main collaboration partners and signatories of the proposal include Josh Cole, Rufford Small Grant and Dr. Justus P. Deikumah from the Department of Conservation Biology and Entomology, University of Cape Coast. Other members are Mrs. Mary Adjei-Ayiah, Richard Kwafu and Prof. K. A. Monney all from UCC.

This project was divided into two phases. The first phase was Indigenous Vulture Monitoring Training Workshop which came off at the Sasakawa Centre, UCC, Cape Coast, Ghana from 10th to 15th January, 2015. Forty (40) participants from seven, out of the ten regions in Ghana, were trained. The participants have been loyal and have sent data to an online database they created as part of the training obligation.



*Participants at the first IVMP training workshop at the Sasakawa Centre in UCC*

The team also had One Day Vulture Monitoring Training Workshop at G.M Afeti Auditorium, Ho Polytechnic, Ho, Volta Region on the 7th April, 2016. There were no participants from Greater Accra, Volta, and Eastern Regions of Ghana during the Cape Coast Training Workshop hence IVMP team decided to organise a one-day training workshop in the Volta Region, in order to first capture some volunteers from the area and also intensify awareness creation. This one-day training workshop was held in collaboration with the Ho Polytechnic in the Volta Region. During the workshop, participants were trained in the skills of vulture identification and monitoring aimed at building local capacity for vulture conservation. This workshop attracted a Representative of the Volta Regional Minister, Madam Helen Ntoso who read a speech on her behalf. In attendance were also Chiefs, Schools, Colleges, political parties, heads of relevant government and private institutions, religious groups, heads of institutions, butchers, artisans, as well as traders from the three regions. The participants, who were trained, provided reports on vulture sightings and activities from their respective communities. This added to the data already accumulated to establish baseline information of the population trend and status of vultures in Ghana.



*Participants at the one-day training seminar in Ho Polytechnic. Seated in the fourth, fifth and sixth seats of the first row are invited chiefs of some communities in the Volta Region*



*Participants at the one-day training by the project director. In attendance was the Ho-Kpodzi E.P Church Dela Cathedral Choir in uniform*

## **Indigenous Vulture Monitoring Project (IVMP)**

Second Phase of the IVMP project is the Vulture surveys and interview, which is financed by Mohammed Bin Zayed Species Conservation. This phase of the projects build on capacity from the first phase where trained participants were tasked to provide weekly or monthly updates on vulture sightings and activities in their local communities. The IVMP team received data from about 120 communities for the first stage of the second phase. The second stage participants provided information from their respective localities. More than 460 people were interviewed from five regions to solicit perceptions and attitudes about vulture conservation in Ghana. Three articles have been drafted for submission to international peer-reviewed journals. Abstracts and drafts are available on demand, but will be made fully available including metadata once they are published. Declarations of funding source for these papers have been stated clearly. The Project director was invited to present two papers at the 2nd Pan African Vulture Summit by the IUCN Specialist Group in Dakar, Senegal (October, 2016).

The project so far has identified some potential threats vultures may be facing. Some of these threats are quiet unique and perhaps peculiar to Ghana and West Africa. Some identified or reported threats are as follows:

- i. The use of old lorry tyres at abattoirs / slaughter houses to single slaughtered animals.
- ii. A unique poisoning pathway through bush meat hunting. Currently, in Ghana, hunters have resolved to use Furadan 4F-Urine concoction for hunting. They poison bait with this concoction and when animals (Grass-cutters) feed on this poisoned bait they die. Hunters then remove the offal of the dead animals and dispose them. When vultures eat this poisoned offal they may die. Almost 100 out of 460 people interviewed so far affirmed this in the course of the interviewing process.
- iii. It has been observed that there is a direct association between hooded vultures and Ceiba pendandra, the Silk cotton (locally called Onyina) tree. The over exploitation of this tree for furniture and construction in recent times also posed a threat and that it was possible that the drastic decline in the number of this tree corresponds to loss of breeding sites for vultures. Perhaps, a co-extinction hypothesis could be tested as part of this study.
- iv. The use of vulture for traditional medicine and trade in its parts pose a threat to vultures. On the local traditional market, vulture parts (egg, head, feathers, legs) are very valuable and expensive.



This situation has kindled the interest of many traditional healers since the trade is lucrative and rewarding.

### ***Awareness on Straw-Coloured Fruit Bat Invasion on UCC Campus***

The current situation of fruit bat evasion on the UCC campus cannot be over emphasised. This present situation is not different from what occurred in Accra, specifically outside the 37 Military Hospital. These were the same species of fruit bats that caused serious problems for the management of the hospital until drastic measures which went as far as direct shooting had to be taken to control the population. It was noticed that in some few months the bat population on UCC campus has been rising steadily. Current trends were that the population was likely to explode and if immediate actions were not taken to curb the situation, the ripple effect of that population explosion could be catastrophic.



*Straw-coloured bats in flight*

It was in this view that the team took up the challenge to educate the general public on the bat invasion on UCC campus and what to do when any of them comes into contact with these bats. The programme targeted the UCC Community, elementary schools, Junior High Schools, Senior High Schools, Churches, Chiefs, environmental officers, estates officers, development officers of the various communities around the university, Metropolitan Assemblies, Media, Park Managers, Environmentalists and individuals.

The team had thirty (30) minutes free airtime twice from the management of ATL FM, Ahomka FM and Cape FM all in the Cape Coast Metropolis on their Morning Show programmes on Thursday, 19th May, 2016, Friday, 20th May, 2016, and Monday, 30th May, 2016 to speak on the topic: *"Bats invasion on UCC Campus: the way forward"* which was presented by Prof. K. A. Monney (Project Coordinator), Dr. Justus P. Deikumah (Operations Director), and supported by the Secretary to the Project, Mrs. Mary Adjei-Ayiah. There were announcement and invitation to listeners to attend the awareness programme on Tuesday, 31st May, 2016.

The main programme scheduled for 31st May, 2016, as expected, was attended by many people. The programme was to be chaired by the Vice Chancellor who was away for an official assignment and in his absence; the Pro-Vice Chancellor to representing him.



*Prof. G.K.T Oduro, Pro-Vice Chancellor addressing the gathering.*



*A section of participants*

There were two presentations for the day by Prof. K. A. Monney and Dr. Justus Deikumah. In the first presentation, Prof. K. A. Monney enlightened the audience on the defining characteristics of bats, the similarities between the bat and other mammals, types of bat, their habitat, etc.. He indicated that the types on UCC campus are the straw-coloured bats.

Dr Justus Deikumah, on his part, indicated that bats have found the UCC campus as very habitable since they are not killed unlike in other urban areas. He also intimated that, the deforestation around the UCC community might have been a likely cause of the migration of the bats to campus. He, therefore, called for regulations to safeguard biodiversity. "Bats are not foes but it depends on how we treat them in our environment", he said. Explaining the dangers posed by the animals to humans, he said that bats can transmit diseases like rabies and other deadly diseases like ebola. He also mentioned that if the habitats of bats, the forests, are destroyed, bats may end up seeking refuge on rooftops and in buildings. He therefore challenged academics to research on how vultures could be housed and handled in times when they invade communities.

The seminar was covered by TV stations, including the national broadcaster GTV, radio stations within Cape Coast and the public relations office for publication on the university's website.

In the opinion of the organisers, the first ever public education on straw-coloured fruit bats was very successful. The message on the

straw-coloured fruit bat on UCC campus came to many as a shock initially but later they have realised the importance as well as the threats these bats can cause to man and the environment.



*Straw-coloured bats in their place of abode*

## **Campus Bat Control Project – UCC**

This project is being funded by the Management of UCC. The aim of this project is to control the population of straw-coloured bats on UCC campus. Specifically, the project seeks to:

- to estimate the population of straw-coloured fruit bats present on the UCC campus.
- to reduce the nuisance caused by straw-coloured fruit bats on the UCC campus.
- to reduce bat-human contact that potentially increase the risk of transmission of zoonotic diseases.
- to test for the presence of Ebola virus and other zoonotic diseases in straw-coloured fruit bat populations found on the UCC campus to inform policy direction.
- explore the potential for research in ecology and behaviour of fruit bats to inform future management decisions.

## **Environmental Monitoring and Impact Assessment of High-Risk Analytes in Produced Water from Oil and Gas Industry**

This project seeks to proffer solutions to problems that emanate from produced water discharge into water bodies and human habitats. Thus, the need to study both the physical and chemical properties of produced water which may vary considerably depending on geographical location of the field, its geological formation, as well as the type of hydrocarbon product being produced. Appreciation of produced water characteristics would help operators increase production, and determine mode of waste discharge to mitigate any environmental effects. Hence, the focus of this work is to help characterise and evaluate the constituents of produced water at the production wells and dumping sites for the purposes of regulatory compliance and selection of management/disposal options. It is also aimed at studying the possible environmental effects of both naturally occurring and treated chemicals on the mining communities to offset future produced water related disease outbreaks. This project will also examine the impact of small scale and offshore petroleum mining activities on aquatic systems, wetlands and farming communities within the catchment areas.

The outcome of the research work seeks to:

- i. provide baseline parameters to both community and industry for future chemical and toxicological analysis
  - ii. obtain water that is ready for use (dust control, make-up water, irrigation).
  - iii. assess the potential applications in the areas of Power Industry (process water), Oil & Gas Industry (recycled water and cementing), and Agriculture (irrigation and livestock watering).
  - iv. proffer solutions for the need to have “zero discharges to sea” (operating companies must use modelling tools for reduction of potential harmful discharges into the environment). This requires the determination of PEC/PNEC ratio (Predicted Environmental Concentration / Predicted No Effect Concentration).
- PEC is the concentration of chemical exposed to the environment during discharge.
  - PNEC is the concentration below which unacceptable effects on organisms will most likely not occur.
  - A PEC/PNEC ratio > 1 indicates that unacceptable effects on organisms are likely to occur.



The ratio is just an indication of the likelihood that possible impacts may occur. The first activity that was carried out in this project work was to mobilise resources for the commencement of the project work. All available transportation arrangements were made to the various sites where samples were collected. These initial activities took two months to be organised. After the mobilisation and transportation arrangement activities, the sampling activities started.

Three different sampling sites were planned based on the design of the work methodology. These sites are as follows; Tullow Produced Water Site, UCC site and The Cape Three Points site. The samples were taken with their various GPS coordinates. Produced water sampled was collected from Tullow Oil rig site (N 04°49'27.8, W 02°9'16.66.7). Samples were also collected from Cape Three Points (N 04°44' 25.7 W 002° 05'31.9), which is the closest shoreline to the rig site and can directly and likely receive the impact of produced water from Tullow operations. The control sample is the shoreline of the University of Cape Coast (N 05°06' 00.4, W 001°16' 59.9), which is more than 100 km from Tullow operations site. Three separate samples of 2 litres were collected, stored and conveyed in polypropylene containers and transported to the laboratory.

### *Problem to be addressed*

In the past, there was an assumption that wastes discharged into the ocean from offshore oil and gas installations were rapidly diluted to safe levels by the hydrological processes of mixing and dispersing. However, while evidence suggests that rapid dilution does not take place, it is also evident that persistent background contaminations occur in the seawater, sediments and biological organisms. The sources of water pollution that gain most attention are produced waters, drilling mud, and oil spills, cutting and well treatment chemicals as well as process wash and draining waters. The adverse effects of these pollutants on marine system, human health, plants and other animals cannot be overemphasised since they can be very acute or chronic to a very large extent.

### *Relevance of the proposed project*

A thorough understanding of how these pollutants move, react, and persist in the environment is crucial towards finding solutions to the risks they may pose to the Ghanaian public, wildlife, and other resources near the oil mining areas. We believe that our research proposal will help to provide a holistic analysis into produced water chemistry. Again, this research if given the needed financial support will provide insights into the proper treatment and monitoring of off-shore and on-shore produced water to help preserve not only the environment in its pristine state, but also aquatic organisms and human life.

### *The Principal Investigators involved in this project are as follows:*



*Dr. Michael Miyttah (Department of Environmental Science), Dr.-Ing. Samuel Kofi Tulashie (Department of Chemistry, Industrial Chemistry Unit, and Dr. Francis Nsiah (Department of Chemistry)*

## ***NUFFIC/NICHE Capacity Building Project***

This project is currently being implemented by the Water and Sanitation Unit with the support of the Maastricht University in the Netherlands. The overall objective of the project is to strengthen the capacity of the Water and Sanitation Unit of the Chemistry Department of UCC and some selected MMDAs to contribute to the improvement of hygiene and sanitation in the country.

The project has two key objectives. These are:

1. UCC offers sustainable expertise, services and training to the Ministry of Local Government and Rural Development (MLGRD) and other clients;
2. A Water and Sanitation Department to be established at UCC supports the MLGRD's Monitoring and Evaluation Framework

To achieve these objectives, the project is currently supporting the Water and Sanitation Unit to build its staff capacity with four (4) PhDs and three (3) (MScs). It is also assisting the Unit to undertake a review of its curriculum with the active participation of relevant WASH sector institutions and potential employers to make the revised curriculum and new programmes responsive to national needs and challenges.

The project is also supporting a collaboration between the Unit and selected MMDAs to develop a web-based monitoring and evaluation tool for WASH services in the selected MMDAs.



*Marijke Irene Kruithof of the Maastricht University in the Netherlands facilitating a Curriculum Review Workshop held at the Pempamsie Hotel in Cape Coast in November 2015.*

## ***Training of WASH Staff in Selected Metropolitan and Municipal Assemblies in ICT Applications***

This project was carried out at the request of Berenschot International Ghana Branch to provide training services in the field of 'ICT, data and knowledge management' for staff of selected Metropolitan and Municipal Assemblies (MAs) working in the area of WASH (Water, Sanitation and Hygiene) and related fields. Two training sessions comprising a basic course and an advance course were attended by participants drawn from selected MMDAs in the Central and Greater Accra Regions, where the Berenschot International was implementing the Ghana Netherlands WASH programme, with the support of the Embassy of the Kingdom of the Netherlands.

The first training session on Basic ICT, Data and Knowledge Management was attended by 23 out of 25 expected participants between 10th and 12th February, 2015. The main goal of the Basic Training was to equip the participants with basic skills in electronic communication, information retrieval and word processing for office practice. The Advanced Training course, which was attended by 26 participants took place between 10th and 12th March, 2015. The main goal of the course was to equip the participants with operational research methods and data analysis using Microsoft Excel.



*Participants of the training programme undertaking hands-on practice of ICT applications*



*A participant of the training programme receiving her certificate of participation*

## Rehabilitation of Glass blowing Unit at UCC

This project was in response to a call by Skill Development Fund (SDF) of COTVET for a proposal to implement a glassblowing project aimed at facilitating quality teaching and learning of Science in Senior High Schools in Ghana. The Department of Chemistry, in collaboration with the DRIC of UCC, embraced the idea and signed a contract with SDF of COTVET to enable the Department of Chemistry rehabilitate the existing glassblowing unit and acquire new relevant equipment. It is expected that the unit will be capable, not only to produce low cost, but readily available glassware needed for science practicals and reflecting teaching in our schools. The unit will in no doubt eliminate tremendously the difficulties encountered with supply of different types of glassware needed for science practicals in Senior High Schools. It is our strong belief that when the unit is fully implemented and takes off it is able to produce and fabricate all kinds of glassware in adequate quantities, all year round, to meet the needed demand from our stake holders namely; GAST, Conference of Heads of Assisted Secondary Schools (CHASS) and MoE who wholeheartedly endorsed this project and offered their supports.



*Mr. Jonathan Assifuah operating on the Calibration Machine.*



*Mr. Augustine Ala-eta with Quality Control Machine*



*The Glassblowing Unit, Department of Chemistry - Mr. Gabriel Amo-Mensah using the Glass-cutting machine*



*Mr. Jonathan Assifuah, Mr. Gabriel Amo-Mensah and Mr. Augustine Ala-eta standing in-front of the Dryer*

## Design and Construction of AC/DC Operated Microcentrifuge

The main objective of this project is to build a micro centrifuge (portable centrifuge) which operates on AC (alternating current) / DC (direct current (battery and solar)) as its power sources together with buzzer, reset switch, two rotor buckets, safety switch, start switch, stop switch and a timer using local materials.

This will help medical/research officers take samples and run tests at remote areas and in laboratories where both DC and/or mainstream power sources (AC) can be accessed. The current imported centrifuges are not mobile, and hence rely on AC (alternating current) as their source of power supply. Laboratory centrifuges used in laboratories (Teaching, Health centres, and Industries) are bulky and hence making them difficult to be taken to the fields for samples to be processed. They are also very expensive, and in Ghana, research in centrifuge circuitry design and manufacturing is not conducted. The centrifuge constructed had a maximum speed of 2400 rpm and RCF of 645.12 g, with timer duration of 49.33 seconds to 7.27 minutes. Two rotor buckets were used and each had a length of 5cm.



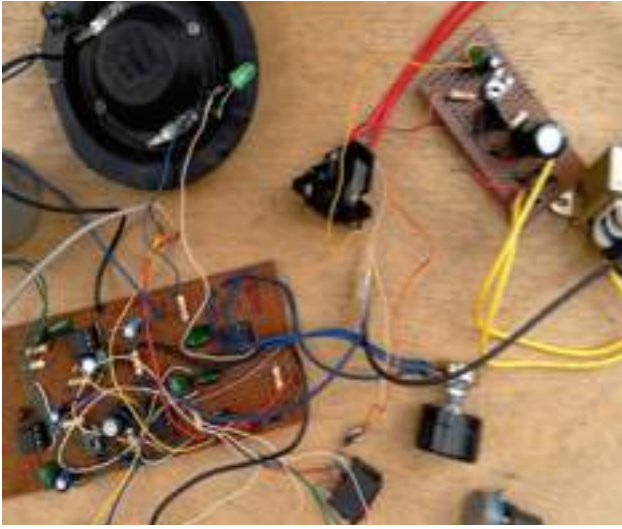

*Pieced circuit parts and accessories*

The designed Centrifuge has the following applications in the Laboratory:

- i. FOOD ANALYSIS** - Centrifugation of food samples, e.g. shito (ground pepper mixture, solution) to determine microbial load, Centrifugal separation of Milk product to determine its microbial contents.
- ii. URINALYSIS**- Microscopic evaluation of urine sediment obtained by centrifugation to determine kidney health status of a person.
- iii. WATER ANALYSIS** - Microscopic evaluation of parasite (motility test) in pond or filtered water for domestic consumption; Separation of contaminants in treated, filtered or sachet water using centrifugal force.
- iv. HAEMATOLOGY** - Centrifugal separation of whole blood serum and plasma to determine the health status.

### *Assessment of Air Quality using DOAS (Differential Optical Absorption Spectroscopy) in Tema Heavy Industrial Area*

**Objective:** To determine the level of gas pollution within the environs of Tema Heavy Industrial Area.

**Status of activity:** Currently on-going with DOAS remote sensing system installed on the premises of TOR. Data is being collected and analysed.

### *Tunable Diode Laser Absorption Spectroscopy (TDLAS)*

**Objective:** To use optical technique for sensing and analysis of gases.

**Date of Activity:** 2006

A tunable diode laser absorption spectroscopic system was donated and currently installed at LAFOC for data collection and analysis.



*Complete assembly of various parts and accessories*



## *Optical Electronic Speckle Pattern Interferometry (ESPI) Project Objective:*

Mach-Zehnder Interferometry for investigating physical properties and characterising materials.



*The ESPI set up*



*Prof. P.K. Buah-Bassuah and Ebenezer Tatchie*

## *Fourier Transform Infrared (FTIR) Spectroscopy and Quantum Cascade Laser (QCL)*

**Objective:** Use of FTIR for the optical characterisation of anti-malaria herbal medicines and QCL for pollution measurements.



*The FTIR system*



*Prof. M. J. Eghan*

## *African Spectral Imaging Network (AFSIN) Project*

**Objective:** Use Multispectral Imaging Spectroscopy and Digital Imaging Processing to analyse Biological Tissues (red-blood cells with malaria) r data collection and analysis.

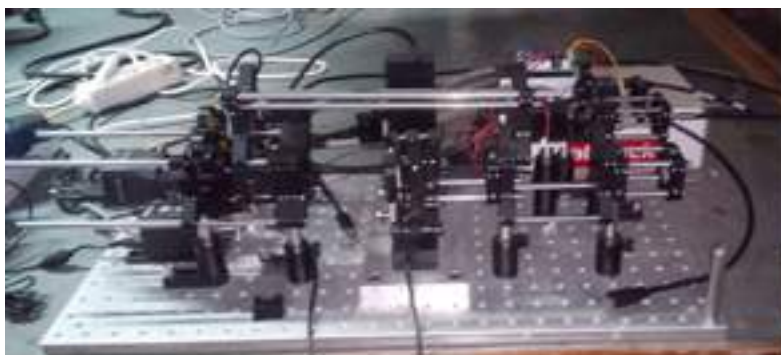

*The Horizontal Microscope used*



*Dr. B. Anderson*

## *Ultraviolet (UV) Transparency Research*

**Objective:** To investigate the transparency of eye-glasses with respect to UV transmission within the UV spectral regions of the electromagnetic spectrum.

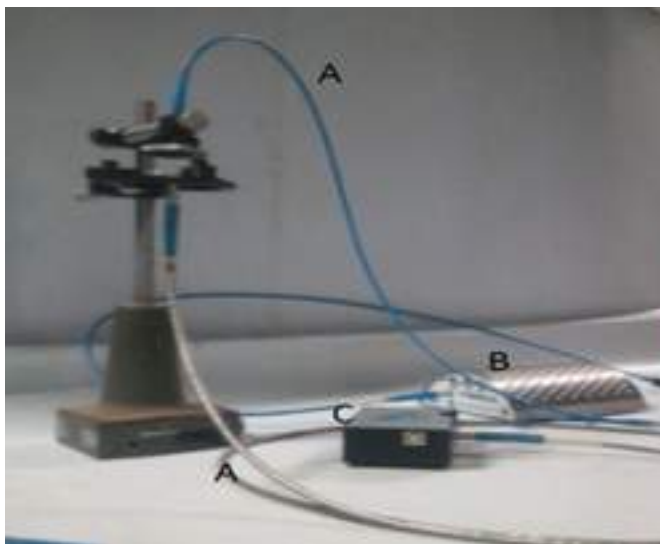

*Dr. S.S. Sackey*



*Setup for UV*



## Nutmeg Sex Determination, Cowpea and Cassava Projects

**Objective:** To use non-invasive optical techniques to investigate some critical concepts in Agriculture. For example, determine the sex of nutmeg plant at its initial growth stage and the use of optical techniques to determine the extent of cassava mosaic infection on a cassava leaf.



Dr. Benjamin Anderson

## Purification of water using Nao-Particles

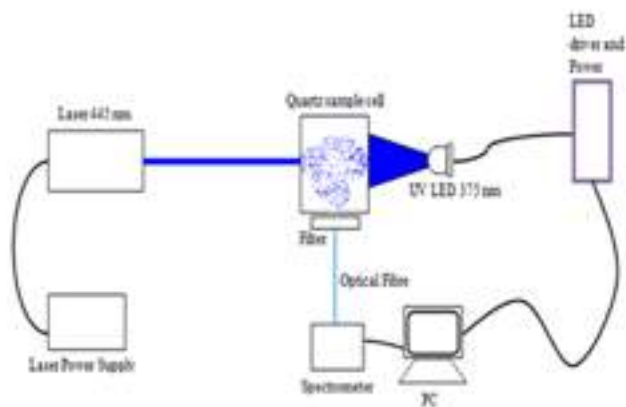

Laser Induced Fluorescence set-up for DOM



Dr. Baah Sefa









# COLLEGE OF EDUCATION STUDIES



**Professor Eric Magnus Wilmot**

Provost of the College of Education Studies

## **Introduction**

*The College of Education Studies (CES) is one of the five Colleges in the University of Cape Coast. The College comprises of the Faculty of Science and Technology Education, School of Educational Development and Outreach, and Faculty of Educational Foundations. CES has the mandate of training high calibre personnel for Ghanaian educational institutions, research educational systems, and training other professionals for all sectors of the economy.*

*The College has the highest number of students and faculty in the University.*

*The vision of the College is to become the centre of excellence for training quality teaching personnel, educational leaders, and specialists as well as technical and professional staff for the Ministry of Education and other sectors of the Ghanaian economy. In doing so, the College is challenged to provide a critical exploration of learning from early years to adulthood and different contexts of learning, both formal and informal.*



## SUMMARY OF FUNDED RESEARCH

No.	Grant Type	Title of Project	Principal Investigator(s)/ Stakeholders	Department(s)	Source of Funding	Total Amount	Status of Project
<b>FACULTY OF SCIENCE AND TECHNOLOGY EDUCATION</b>							
1	Consultancy Project	Training Fishmongers in Improved Fish Smoking Methods	Department of Vocational and Technical Education (VOTEC) (UCC, Ghana)	Department of VOTEC, UCC, Ghana	COTVET	GH¢67,000.00	Completed (2014)
2	Departmental Research Project	Development of Curriculum and Training Module in Computer-Aided Designing for Fashion Designers	Department of VOTEC (UCC, Ghana) St. Michael Infotech Consult; Coastal Network Consortium; Ghana National Tailors and Dressmakers Association	Department of VOTEC, UCC, Ghana	COTVET	GH¢580,125.00	Completed (2014)
3	Research Project	Technological Challenges of using Audience Response System - The Good, Bad and Ugly	Dr. K. Ayebi-Arthur; and Dr. K. A. Owusu (UCC, Ghana)	Department of Mathematics and ICT Education, UCC, Ghana Department of Science Education, UCC, Ghana	Internally Funded Research		On-going
4	Research Project	Classroom Environment Interactions of using Audience Response System	Dr. K. Ayebi-Arthur; and Dr. K. A. Owusu (UCC, Ghana)	Department of Mathematics & ICT Education, UCC, Ghana Department of Science Education, UCC, Ghana	Internally Funded Research		Yet to begin
5	Research Project	Capacity Building in ICT for Local Basic Schools in Ghana (CaBLOG)	Department of Mathematics and ICT Education, UCC, Ghana	Department of Mathematics & ICT Education, UCC, Ghana	Internally Funded Research		Yet to begin

No.	Grant Type	Title of Project	Principal Investigator(s)/ Stakeholders	Department(s)	Source of Funding	Total Amount	Status of Project
<b>SCHOOL OF EDUCATIONAL DEVELOPMENT AND OUTREACH</b>							
6	Evaluation of Activity Based Learning (ABL) Initiatives in Ghana (2010)	Prof. G. K. T. Oduro; Dr. A. Dare; Dr. (Mrs.) R. S. Bosu; and Dr. Hope P. Nudzor (UCC, Ghana)	Institute for Educational Planning & Administration (IEPA), UCC, Ghana	DFID			Completed (March 2012)
7	On-going Research	A Case Study on Girls who have Dropped out of School due to Pregnancy and their Re-entry into School	IEPA, UCC, Ghana	IEPA, UCC, Ghana Girl Education Unit (MoE) and UNICEF	MoE, UNICEF		Proposal sent to UNICEF
8	Internally Funded Research	Tracer Study: Utilisation and Effectiveness of IEPA Graduates	Prof. Yaw A. Ankomah; Dr. Hope P. Nudzor; Mr. Theophilus Danso; Ms. O. Affreh; Mr. A. Acquah; and Ms. Caroline O. Otwei (UCC, Ghana)	IEPA, UCC, Ghana	Internally Funded Research		Nov/Dec 2014
9	Internally Funded Research	Leadership for Learning Project: Research Offshoot: Most Significant Change	Dr. Sue Swafeld (Cambridge University, UK); Dr. (Mrs.) R. S. Bosu; Mr. T. Danso; Ms. G. Nyame; Ms. O. Affreh; and Ms. A. Gyimah (UCC, Ghana)	Cambridge University, UK IEPA, UCC, Ghana	Internally Funded Research		Completed (2015)

No.	Grant Type	Title of Project	Principal Investigator(s)/ Stakeholders	Department(s)	Source of Funding	Total Amount	Status of Project
<b>SCHOOL OF EDUCATIONAL DEVELOPMENT AND OUTREACH</b>							
10	Internally Funded Research	Transitional Experiences of Postgraduate Students of the College of Education Studies, UCC	IEPA, UCC	IEPA, UCC, Ghana	Internally Funded Research		In progress (2016)
11	Research Project	Secondary Education Improvement Project (SEIP)	Prof. Joseph G. Ampiah, and Dr. Might K. Abreh (UCC, Ghana)	Centre for Educational Research, Evaluation and Development (CERED), UCC	World Bank administered by Ghana Education Service	USD100,000,000	On-going (2016-2017)
12	Research Project	Baseline Survey on Degree of Community Participation in Education	Prof. Yaw Ankomah, and Dr. Might K. Abreh (UCC, Ghana)	IEPA, UCC, Ghana CERED, UCC, Ghana	Japan International Cooperation Agency (JICA) Ghana	USD19,750,000	Completed (2015-2016)
13	Collaborative Research Study	Pedagogies for Critical Thinking: Innovation and Outcomes in African Higher Education. ( <i>Pedagogies for Critical Thinking</i> )	Dr. Tristan McCowan, and Dr. Rebecca Schandel ( <i>Institute of Education, UCL, UK</i> ) Dr. Christine Adu-Yeboah, and Dr. Christopher Y. Kwaaah ( <i>UCC, Ghana</i> )	UCL, UK Institute of Education, UCC, Ghana CERED, UCC, Ghana	DFID, UK	GBP4,500,000	Completed (2016)
14		Teacher Trainees' Experience of the Practical Component of the Initial Teacher Education Programme in Ghana	Dr. Christine Adu-Yeboah, Dr. Christopher Y. Kwaaah, and Dr. Might K. Abreh (UCC, Ghana)	CERED, UCC, Ghana	Faculty of Education, UCC	GHC10,000,000	Completed (2013-2015)



No.	Grant Type	Title of Project	Principal Investigator(s)/ Stakeholders	Department(s)	Source of Funding	Total Amount	Status of Project
<b>SCHOOL OF EDUCATIONAL DEVELOPMENT AND OUTREACH</b>							
15	Collaborative Research	Impact of Decentralisation Policy on Improving Access to and Quality of Education in Ghanaian Junior High Schools	Dr. Mikako Nishimuko ( <i>Hiroshima University, Japan</i> ); and Dr. Christopher Y. Kwaah ( <i>UCC, Ghana</i> )	CICE Hiroshima University CERED, UCC, Ghana	Japan Society for the Promotion of Science	USD6,000,000	Completed (2014-2016)
16	Research Project	Evaluation of the Quality and Effectiveness of ACE Methodological and Pedagogical Approaches to Basic Education in Northern Ghana	Prof. Joseph G. Ampiah; Prof. Jonathan A. Fletcher; Prof. Ernest K. Davis; and  Dr. Might K. Abreh ( <i>UCC, Ghana</i> )	Department of Science Education, UCC, Ghana  Institute of Education, UCC, Ghana CERED, UCC, Ghana	IBIS, Ghana	USD9,000,000	Completed (2012-2012)
17	Research Project	Consortium for Research on Educational Access, Transitions and Equity (CREATE)	Prof. Keith Lewin; and Prof. Kwame Akyeampong ( <i>University of Sussex, UK</i> ) Prof. Joseph G. Ampiah; Prof. Jerome Jagmah; and Dr. Christopher Y. Kwaah ( <i>UCC, Ghana</i> )	Department of Science Education, UCC, Ghana  Institute of Education, UCC, Ghana CERED, UCC, Ghana	DFID	GBP71,123.00	Completed (2006-2011)
18	Doctoral Exchange Fellowship	North-South-South Higher Education Institution Network Programme 'Culturally Responsive Education Network'	Dr. Christopher Y. Kwaah ( <i>UCC, Ghana</i> )	CERED, UCC, Ghana  Department of Teacher Education, University of Helsinki, Finland	Finnish Centre for International Mobility (CIMO)	EUR8,000,000	Completed (2013)

No.	Grant Type	Title of Project	Principal Investigator(s)/ Stakeholders	Department(s)	Source of Funding	Total Amount	Status of Project
-----	------------	------------------	---	---------------	-------------------	--------------	-------------------

### FACULTY OF EDUCATIONAL FOUNDATIONS

19	Research	Causes of Poor Academic Performance in BECE in the Abura-Asebu-Kwamankese District	Department of Education & Psychology (UCC, Ghana)	Department of Education & Psychology, UCC, Ghana	Internally Funded Research		On-going
20	Consultancy Project	Complementary Basic Education Learners Assessment	Prof. Francis K. Amedahe Dr. Eric Anane Mr. Benjamin Sokpe	DRIC, UCC	DFID	GHC635,360,000	Completed (2016)
21	Externally Funded Research	Young Children as Apprentice Citizens: A Comparative Case Study Analysis of the Role of Literacy in Empowering Civic Engagement in Ghana and the United States of America	Dr. Felicia K. Etsey; Prof. Clement Aguezo; Prof. Kankam Boadi; Mr. Alex Kwao; Dr. Awo A. A. Sarpong; Ms. Joyce E. Bronteng; Dr. Irene Berson; and Dr. Michael Berson (UCC, Ghana)	Department of Basic Ed Spencer Foundations, UCC, Ghana	Spencer Foundations		Completed
22	Research	Survey on Sexual Harassment in UCC	Prof. Kofi Awusabu-Azare; Prof. Akua O. Britwum; and Prof. Godwin Awabil (UCC, Ghana)	Department of Population & Health, UCC, Ghana CEGRAD, UCC, Ghana Counselling Centre, UCC, Ghana	Internally Generated Fund		On-going

# *DESCRIPTION OF FUNDED RESEARCH*





## Training Fishmongers in Improved Fish Smoking Methods

The Department of Vocational and Technical Education (VOTEC) offered training to members of Anomabo Fishmongers Association to upgrade their knowledge and skills in the use of modern fish smoking facilities; improved preservation methods and processes and proper fish handling and sanitation of their processing facilities and the environment. Over the course of the project, a total of Seventy (70) fishmongers benefitted from the training.



A section of participants at a training section on improved Fish Smoking Methods

## Development of Curriculum and Training Module in Computer-Aided Design (CAD) for Fashion Designers

The project aimed at developing the capacity of Tailors and dressmakers in Ghana in the use of modern technologies and tools to meet the sophisticated needs and growing demand of their clientele. Curriculum and training modules based on the C-Design Fashion v4 software were developed for use by Tailors and Dressmakers in the informal sector as well as Fashion students in formal Technical and Vocational Education Training (TVET) Institutions. The training module was presented in print and video forms. And the video was made available in seven main Ghanaian languages (Fante, Twi, Ga, Dagbani, Ewe, Wala and Frafra). A Trainer of Trainers (ToT) workshop was organised for Master craftsmen

(Regional Executives of Ghana National Tailors and Dressmakers Association-GNTDA) on how to use the curriculum and module.



### List of Research Collaborators

- DFID
- UNICEF
- UNESCO's International Institute for Educational Planning (IIEP)
- Nigeria Institute of Educational Planning and Administration.

### List of International Partners (Both Teaching and Research)

- Auburn University
- Cambridge University
- DFID
- UNICEF
- UNESCO's International Institute for Educational Planning (IIEP)
- Nigeria Institute of Educational Planning and Administration.

### Research-related Community Services/Activities/Engagements

- T-Tel

### Evaluation of Activity Based Learning (ABL) Initiatives in Ghana (2010)

The DFID, Ghana sponsored research project was undertaken by a team of researchers under the auspices of the IEPA/UCC between December 2011 and August 2012. The research project aimed, among other things, to fill in knowledge and data gaps with the aim of influencing education policymaking with respect to ABL in Ghana; and to see how learning outcomes are and/or could be transformed through learner-centred pedagogy to enable a move toward a Ghanaian activity-based learning concept and framework.

### Participants of ABL research



Researcher observation of lessons



*Group work examples of ABL*

### *Tracer Study: Utilisation and Effectiveness of IEPA Graduates*

This research was a departmental research sponsored by IEPA. The primary purpose of this tracer study was to find out how IEPA graduates are utilised by their employers and how efficient and effective they are at their respective places of work. A secondary purpose of the research was to identify any gaps and/or lapses in the knowledge, skills and expertise of IEPA graduates that may require revision of the IEPA's curricula and general modes of training as well as course content.

### *Leadership for Learning project; Research offshoot: Most Significant Change*

The main purpose of Leadership for Learning (LfL) is to strengthen leadership capacity and improve the quality of learning through leadership. There is also the ultimate aim of influencing policy makers to make leadership development a condition for appointing basic school headteachers. LfL derives its theoretical base from the Leadership for Learning Cambridge Network which has developed a framework to explore the interconnectedness of learning and leadership. This framework is a result of studies conducted in seven countries, eight sites and twenty-four schools and sponsored by the Swedish charity 'Carpe Vitam'.



*Group discussion with school head teachers*



### *Transitional Experiences of Postgraduate Students of the College of Education Studies, UCC*

Settling-in problems are often a bother to all sorts of persons. But for the postgraduate student in an unfamiliar new physical and social setting, these problems can be overwhelming and sometimes affect the performance of the student at least in the beginning year. In recognition of this, the Institute for Educational Planning and Administration (IEPA) of UCC, is undertaking an exploratory study to examine the transitional challenges of postgraduate students of UCC. The rationale, essentially, is that the findings of this study will unearth the transitional problems that fresh students of UCC face, and would in turn orient the University Management to take practical and responsive measures to assist fresh students of the University deal with their transitional issues.

### *Complementary Basic Education (CBE) Learners Assessment*

Professor Francis Amedahe led a team of educational evaluators to conduct a baseline and endline assessment of a DFID sponsored project on CBE. The CBE evaluation is intended to assess the proficiency of children participating in the CBE programme in literacy and numeracy at the time of enrolment to CBE classes, at the time of completion of CBE classes, and compare the learning achievement by sex, geographical regions, implementing models and implementing agencies. The programme comprised the development of assessment instruments, pilot-testing of the instruments, training of field staff, data collection and data analysis.



### *Using Audience Response System (ARS) in a Third World Country - The Good, Bad and Ugly*

This project seeks to explore how audience response system can be utilised in teaching at the University of Cape Coast. The specific audience response system being used in this study is the Socrative app. This exploratory study uses the free version of the app. Both the student and teacher options of the app were used. As an exploration study, the aim is to identify how effective ARS can be as an instructional tool, the positives that it can add to the teaching as well as learning process and the difficulties that may arise with the use of ARS.

### *Classroom Environment Interactions when using Audience Response System*

An effective classroom is where there are various forms of interactions: student-student and teacher-student. Unfortunately, most of the interactions that go on in our lecture theatres are minimal. Lecturers tend to deliver their content with minimal to no interactions with the students. How best can we foster student-student as well as lecturer-student interactions in the lecture theatre? This research seeks to make use of an audience response system to explore the possibility of improving the interactions that go on in the lecture theatres. The hope is that through the use of this system, students will be able to interact with their colleagues as well as with the lecturer during lectures.

### *Capacity Building in ICT for Local Basic Schools in Ghana (CaBLoG)*

The project aims at capacity building in ICT for Local Basic Schools in Ghana. The Department will collaborate with GES and relevant Ministry in the following areas: Trainings - capacity building sessions; Sensitisation; Computers; Furniture; Manuals and Partnerships. These will be achieved through collaborative programmes within and outside the University of Cape Coast.

### *Survey on Sexual Harassment in UCC*

The research is aimed at examining the extent to which members of the University are aware of the sexual harassment policy, assess strategies for implementation and solicit suggestions for improving the implementation of the policy.









# COLLEGE OF HEALTH AND ALLIED SCIENCES



**Professor Johnson Nyarko Boampong,**  
Provost of the College of Health and Allied Sciences

## Introduction

*The College of Health and Allied Sciences (CoHAS) is responsible for developing and administering programmes related to the education of healthcare professionals. The academic unit of the College consists of the School of Medical Sciences (SMS) School of Nursing and Midwifery (SoNM) and the School of Allied Health Sciences (SAHS). These schools offer nationally recognised programmes, using two affiliated Teaching Hospitals (the Cape Coast Teaching Hospital and Effia Nkwanta Teaching Hospital at Sekondi), a vast array of collaborating hospitals and health centres in the Central Region, a distinguish faculty, and locations that offer countless resources. CoHAS provides students with a rich educational experience that is second to none.*

## Vision

A global school of excellence whose members blend technology, professional will and humility to positively advance health, driven by bold leadership in ethics, academic excellence, research, community service and professional development. The college is well positioned to be an acclaimed public provider of quality health professional education.

## Mission

The primary mission of the College is to provide educational excellence and achievement of learners by preparing them to be caring, community-oriented, professionally responsible, competent professionals in a fast growing industry.

### **Our mission is to:**

a) provide medical and allied health professional education of the highest standard and value in Ghana, and the West African sub-region by blending internationally validated curricula with the unique healthcare needs of Ghana and Africa.



b) produce high calibre medical and allied health practitioners/scientists who will challenge conventional paradigms through innovation research, and yet pragmatic, with an unwavering priority of advancing the immediate healthcare needs of ordinary people and communities in Ghana and West African sub-region.

c) train medical and allied health practitioners, and researchers who are motivated to maintain excellence in all aspects of clinical, basic science, and community-based participatory research, adhering to international accepted principles of humane and ethical behaviour, conscious of the ethical, legal and social implications of genomic sovereignty and intellectual property.

d) train, mentor and provide opportunities for our students and teachers to become leaders who shape national and regional policies in health and technology to safeguard the health and wellbeing of ordinary people.

e) develop outstanding flexible clinical and basic continuing educational programmes, as well as quality assurance programmes that are recognised internationally, to serve the needs of aspiring and qualified medical and allied health professional, and entrepreneurs, as well as government agencies in Ghana, and the West African sub-region.

f) establish centres of excellence in research and service by seeking and maintaining the most advanced diagnostic and research technologies, and applying innovation approaches to advance the knowledge in disorders that extract a major health burden on Ghana and Africa.

### **Educational Goals**

In line with the stated mission, the CoHAS' educational goals are to:

- produce competent health professionals who possess a sense of social, personal, and professional responsibility and can assume leadership and management roles in a variety of health care systems;
- encourage interdisciplinary education and practice among students and faculty;
- promote critical thinking and problem based learning which build on prior educational and life experiences;
- stimulate interest in, and provide opportunities for continued professional development, research and graduate studies;
- provide medical care and preventive healthcare services to the university and the local communities;
- provide continuing education workshops for health professionals;
- develop and implement health professions programmes to meet current and future health needs of the community.

### **As a College, we believe:**

- that the student is the most important person on the campus and that without them, there will be no institution
- that the world, especially, the academic and health professions communities is becoming an increasingly global society
- that there is strength in diversity and that it is our responsibility to ensure students' success
- training our students to appreciate that quality service is the foundation for excellence in the healthcare professions
- in promoting excellence in teaching, learning, scholarship and service
- that learning is a dynamic lifelong process

### **Core Value**

The College of Health and Allied Sciences' shared values are:

- Professional Integrity
- Academic Excellence (Promoting Students Learning)
- Inter-professional Education and Collaboration (Team work)
- Critical Thinking
- Lifelong Learning
- Leadership and Ethics
- Accountability and Responsibility
- Innovation
- Advocacy

### **Major Activities of the College**

The College of Health and Allied Sciences offers rigorous curricula grounded in the sciences connected to the healthcare professions, placing emphasis on contemporary issues. Our curricula are built on our commitment to interdisciplinary inquiry, international understanding, interactive teaching, research and creative endeavours, practical application, and social responsibility towards all communities.

Our community outreach activities are based on these commitments and include activities such as elective placement programmes in other hospitals (and facilities) within the country as well as internationally Community-Based Experience and Service (COBES) postings, and opportunities to conduct research with faculty. These activities allow students to craft unique and personalised educational experiences. With COBES site as their extended "classroom" without walls, our students are able to take advantage of the vast opportunities offered by pristine rural environment to be innovative and, therefore, impact the communities positively, thus helping to improve the lifestyle and living conditions of the residents.

## Objectives

The objectives of the College of Health and Allied Sciences are to:

- build enduring assets, capital and partnership
- establish quality assurance programmes
- engage the local community and protect the public through quality professionals and the delivery of expert healthcare and support services.
- expand and continue to grow to meet new challenges and demands in the healthcare industry.
- develop and sustain scholarly activities.
- increase our public profile.
- establish a business, finance and administrative core.
- promote and conduct cutting-edge research that will not only contribute to knowledge, but also provide solution to challenging issues affecting the health of our people.

## Achievements

Since the inception of the School of Medical Sciences in 2008, we have graduated five (5) batches of doctors totaling two hundred and fifty four. We have also been training Optometrists and Medical Laboratory Scientists. Our academic curricula, which are strongly community-oriented, also provide much needed healthcare-related support to the communities we work in.



## SUMMARY OF FUNDED RESEARCH

### SCHOOL OF MEDICAL SCIENCES

No.	Grant Type	Title of Project	Principal Investigator(s)/ Stakeholders	Department(s)	Source of Funding	Total Amount	Status of Project
1	Collaborative Research Project	Ghana Breast Cancer Registry and Biomarker Project	Dr: Akwasi Anyanfulu; Dr: Frank Chartery; Dr: Kafui Akakpo: and Prof: Samuel Debrah (UCC, Ghana) Prof Nils Brunnerqa (Sino-Danish Breast Cancer Research Centre, Denmark)	Department of Medical Biochemistry, UCC, Ghana  Department of Chemical Pathology, UCC, Ghana  Department of Pathology, UCC  Department of Surgery, UCC, Ghana  Department of Veterinary Disease Biology, University of Copenhagen, Denmark	Personal Funding and Grant Seeking	USD100,000,000	Early Stages
2	Collaborative Research Project	Assessing a Novel Mathematical Model for Optimisation and Effectiveness of Individualised Therapy for Breast Cancer	Dr: Frank Chartery; and Prof: Martins Ekor;  Dr: Akwasi Anyanfulu; and Prof Samuel Debrah (UCC, Ghana)	Department of Chemical Pathology, UCC, Ghana  Department of Medical Biochemistry, UCC, Ghana  Ghana Department of Surgery, UCC, Ghana	Personal Funding and Grant Seeking	USD100,000,000	Early Stages



No.	Grant Type	Title of Project	Principal Investigator(s)/ Stakeholders	Department(s)	Source of Funding	Total Amount	Status of Project
<b>SCHOOL OF MEDICAL SCIENCES</b>							
3	Comparative and Collaborative Research Project	Visualisation of Tumour Related Angiogenesis and Detection of Breast Tumours in Ghanaian Women: A combined Clinical and Optical Methodology for Breast Cancer Screening	Dr. Frank Ghartey; Dr. Akwasi Anyanful; Dr. Martin Morna; and Prof. Samuel Debrah (UCC, Ghana) David Watmough (Highland Innovation Centre, Scotland)	Department of Chemical Pathology, UCC, Ghana  Department of Medical Biochemistry, UCC, Ghana  Department of Surgery, UCC, Ghana  Department of Surgery, UCC, Ghana Highland Innovation Centre, Scotland	Personal Funding and Grant Seeking	USD20,000.00	On-going (2012-2018)
4	Collaborative Research Project	Hepatitis B Virus Infection in Pregnant Women in Ghana: Effects of Pro-Inflammatory Antiviral Activity on Successful Pregnancy	Dr. Samuel V. Nuvor; and Mr. Bright Ayensu (UCC, Ghana)  Prof. Benjamin Gyan; and Dr. Asamoah Kusi (UG, Ghana)	Department of Microbiology & Immunology, UCC, Ghana  Department of Immunology, UG, Ghana	Personal Funding Seeking for Funding	GHC15,000,000	Initial Stages (2017- )
5	Collaborative Research Project	Immunological Profile in HIV Infected Pregnant Women Visiting the Cape Coast Teaching Hospital in Ghana	Dr. Samuel V. Nuvor; Mr. Kwabena Dankwa; Dr. (Mrs.) Dorcas Obiri-Yeboah; and Mr. Simeon Aidoo (UCC, Ghana)	Department of Microbiology & Immunology, UCC, Ghana	Personal Funding, Seeking for Funding	GHC50,000,000	Initial Stages (2017- )

No.	Grant Type	Title of Project	Principal Investigator(s)/ Stakeholders	Department(s)	Source of Funding	Total Amount	Status of Project
-----	------------	------------------	---	---------------	-------------------	--------------	-------------------

### SCHOOL OF MEDICAL SCIENCES

6	Collaborative Research Project	Body Fat, Non-alcoholic Fatty Liver Disease and Cardiovascular Risk among Patients at the Cape Coast Teaching Hospital, Cape Coast, Ghana	Dr: Ansumana S. Bockarie; Dr: Paul Nsiah; Dr: Kobina Edzie; Dr: Derrick Touyire ( <i>UCC, Ghana</i> ) Dr: Bernard Nkum ( <i>KNUST, Ghana</i> )	Department of Internal Medicine, UCC, Ghana  Department of Chemical Pathology, UCC, Ghana  Department of Radiology, UCC, Ghana  Department of Community Medicine, UCC, Ghana  Department of Internal Medicine, KNUST, Ghana	UCC, Ghana Personal Funds	GHC35000000	Write up (Due for completion in 2017)
---	--------------------------------	---	--	---	------------------------------	-------------	---------------------------------------

7 Collaborative Research Project  
 Trial for the Reduction of Infant Undernutrition Through Modified Feeding (TRIUMF)  
 Prof. Harold S. Amonoo-Kuofi;  
 Dr: Paul Nsiah; and  
 Mr. T. K. Johnson  
 (*UCC, Ghana*)  
 Prof. K. Tano-Debrah; and  
 Dr: Gloria E. Otoo (*UG, Ghana*)  
 Dr: Shibani A. Ghosh  
 (*Tufts University*)

CoHAS, UCC, Ghana  
 Department of Chemical Pathology, SMS, UCC, Ghana  
 Department of Chemical Pathology, UCC, Ghana  
 Department of Nutrition and Food Science, University of Ghana, Ghana  
 Department of Nutrition and Food Science, University of Ghana, Ghana  
 Nevlin Scrimshaw International Nutrition Foundation, USA  
 Ajinomoto Co., Inc., Japan

Ajinomoto Co., Inc., JICA (Japan International Cooperation Agency)

USD177,347.00 Completed (2013-2015)

No.	Grant Type	Title of Project	Principal Investigator(s)/ Stakeholders	Department(s)	Source of Funding	Total Amount	Status of Project
<b>SCHOOL OF MEDICAL SCIENCES</b>							
8	Collaborative Research Project	Molecular Epidemiology of Rotavirus in Children under Five in Africa	D. Ouermi; J. Simporé; T.M. Zohoncon; and F.W. Djigma D. Soubeiga; and P.M. Sawadogo W.M. Nadermbèga Dr. Dorcas Obiri-Yeboah (UCC, Ghana) J. Nordgren (University, Linköping, Sweden)	CERBA/LABIOGENE Research Centre, Ouagadougou, Burkina Faso  IFRIS, Ouagadougou, Burkina Faso  University of Saint Thomas, Ouagadougou, Burkina Faso  Department of Microbiology & Immunology, UCC, Ghana  Department of Clinical and Experimental Medicine, Linköping University, Linköping, Sweden	Pietro ANNIGONI Association and the WAEMU Commission through the PACER-II programme	USD80000.00	First manuscript published
9	Collaborative Research Project	Haematological and Biochemical Changes in Patients at the Antiretroviral Therapy Clinic	Dr. Dorcas Obiri-Yeboah; Ms. Alice Charwudzi; Dr. Paul Nsiah; Prof. Ivy Ekem; and Mr. Ibrahim Kwame Baidoo (UCC, Ghana)	Department of Microbiology & Immunology, UCC, Ghana  Department of Haematology, UCC, Ghana  Department of Chemical Pathology, UCC, Ghana  Department of Haematology, UCC, Ghana  Public Health, Cape Coast Teaching Hospital (CCTH), Ghana	Personal Grant Seeking	GHC22,400,000	Data collection phase



No.	Grant Type	Title of Project	Principal Investigator(s)/ Stakeholders	Department(s)	Source of Funding	Total Amount	Status of Project
-----	------------	------------------	---	---------------	-------------------	--------------	-------------------

### SCHOOL OF MEDICAL SCIENCES

10	Collaborative Research Project	Quinolone Resistance (qnr) Genes in Fecal Carriage of Extended Spectrum Beta-Lactamases Producing Enterobacteria Isolated from Children in Niger	A. Moumouni; S. Diabougoua; C. Nadembéga; F. Djigma; T. Zohoncon; and J. Simpre Dr. (Mrs.) Dorcas Obiri-Yeboah (UCC, Ghana) C. Langendorf	CERBA/LABIOGENE Research Centre, Ouagadougou, Burkina Faso  Department of Microbiology & Immunology, UCC, Ghana  Epicentre, 8 rue Saint Sabin Paris 75011, France	West African Economic and Monetary Union (WAEMU) Commission, Ouagadougou, Burkina Faso	USD10,00000	First manuscript published
----	--------------------------------	--	---	---	--	-------------	----------------------------

11	Collaborative Research Project	Retinal Microvasculopathy in HIV/AIDS at CCTH, Ghana	Emmanuel K. Abu; Samuel Abokyi; Samuel B. Boadi-Kusi; and Daniel Afedo; and Dr. (Mrs.) Dorcas Obiri-Yeboah Richard K.; D. Ephraim; Lawrence D. Agyeman (UCC, Ghana)	Department of Optometry, UCC, Ghana  Department of Microbiology & Immunology, UCC, Ghana  Department of Medical Laboratory Science, UCC, Ghana	Personal Contributions	GHC9,400000	First manuscript published
----	--------------------------------	--	---	--	------------------------	-------------	----------------------------



## DESCRIPTION OF FUNDED RESEARCH

### *Ghana Breast Cancer Registry and Biomarker Project*

In Ghana, 65% of women diagnosed with breast cancer die from aggressive tumours which are resistant to hormonal therapy and have a higher risk of being triple negative. Breast cancer is a heterogeneous disease and patients with similar staging and histology show differences in tumour growth rates and treatment response even within similar demographic populations. This merits intensive studies to improve diagnosis and treatment for Ghanaian breast cancer patients to reduce the levels of deaths. We are at the initial stages of a joint venture between University of Cape Coast and Sino-Danish Breast Cancer Research Centre to establish the first Breast Cancer Research and Resource Centre in Ghana. This Centre will

- (i) generate national breast cancer registry by conducting descriptive epidemiological studies. This registry will be available to all stakeholders and also be a guide for future personalised treatment.
- (ii) elucidate and characterise unique biomarkers present

in Ghanaian breast tumours after setting up standard tissue preparation procedures for each patient. The results will reveal differences between Ghanaian and other known (Caucasian) breast cancer biology and subsequently establish a genomic landscape for comparison. Furthermore, the results can be used as a foundation for innovative clinical trials in Ghana. We believe this study could lead to the discovery of new breast cancer risk factors which might be targeted in future intervention programmes. The molecular characterisation of Ghanaian Breast Cancers may pave the way for a paradigm shift from “one size fits all” to “individualised treatment” in Ghana.

The project proposes a training programme for a postgraduate student from Ghana to analyse the demographic data from Ghanaian breast cancer patients and compare with similar data on Danish (Caucasian) breast cancer patients. Findings from the research including the molecular characterisation results may shed light on the very poor prognosis of Ghanaian breast cancer patients and offer an alternative way of applying breast cancer therapy in Ghana.



*Dr. Akwasi Anyanful of University of Cape Coast in Denmark to establish a Joint Research Collaboration with Professor Nils Brunner, Director of the Sino-Danish Breast Cancer Research Centre*

### *Assessing a Novel Mathematical Model for Optimisation and Effectiveness of Individualised Therapy for Breast Cancer*

In Ghana, over 70% of breast cancer cases presented to hospitals are in advanced stages of the disease. Thus, the first line of treatment is primarily surgery, followed predominantly by chemotherapy. When applying chemotherapy, it is important to avoid overtreatment or under treatment and spare patients the toxic side effects if they will not benefit from chemotherapy. Thus tailoring treatment to ensure each individual breast cancer patient receives optimal therapy based on the biological characteristics of their tumours is crucial. We have developed a novel mathematical model based on treatment results that pre-determines how treatment for breast cancer can be individualised for optimum benefits. In deriving the equation, we used the prognostic and predictive proliferation marker "Ki67" as well as tumour stage to derive the tumour biological coefficient and patients' constant. The latter represents patients' unique response to treatment in terms of survival in years, per cycle of chemotherapy received singly or in combination. The overall model is governed by the equation:  $Sc = Kc [NCC] \times [TS] [Ki67]^{-1}$ , where  $[TS] [Ki67]^{-1}$  is the tumour biological coefficient,  $[NCC]$  number of cycles of chemotherapy and  $[Kc]$  is the survival index (constant) - number of years survived/cycle of chemotherapy - for the patients under study. With a known  $Kc$ , we now use it to pre-determine individualized treatment for any patient (Pt) using the equation  $Pt = Kc \times [TS] [Ki67]^{-1}$ . This designed model, based on successful treatment results, can predetermine the number of cycles of chemotherapy each patient requires for optimum survival and it is in line with the

ultimate goal of personalized treatment. This model is applicable for treating other cancers which present with solid palpable lesions and could revolutionise cancer treatment. We are currently at the recruiting stages of this project.

Breast Cancer Project team - Akwasi Anyanful, Frank Ghartey, Martins Ekor and Samuel Debrah

### *Visualisation of Tumour Related Angiogenesis and Detection of Breast Tumours in Ghanaian Women: A Combined Clinical and Optical Methodology for Breast Cancer Screening*

Late stage neoplastic breast lesions abound in Ghana, especially, late-stage early-age breast cancer. Therefore low survival rates after treatment of breast cancer is prevalent. The median age of diagnosis for breast cancer is thirty-nine (39) years hence screening mammography ("the gold standard") is not suitable and also not readily available in Ghana. Findings of breast screening that raises suspicion of breast cancer require further investigations with the aim of detecting early stage of the disease. Preliminary investigations using transillumination offer a new mode of early detection for neoplastic breast lesions. This process however is not limited by age and high cost. So far, 9962 women have been manually screened for breast lesions during our breast cancer awareness and mobile breast screening clinics with the view to enhance early detection. Screening was offered by transillumination with the Breastlight/Breast-I, a torch-like device that detects angiogenesis. This device, which operates on absorption of light by haemoglobin in blood at a specific wavelength, was used to visually assess angiogenesis around breast tumours and lesions. By allowing visual assessment of tumour-related angiogenesis, all suspicious and potentially malignant lesions were referred for followed up, while non-suspicious lesions are checked again after six months. This research is currently on-going and we plan to screen 40,000 women in Ghana. This combined clinical and optical methodology for breast cancer screening, it is to ensure that detection rate of breast lesions is more feasible, comes at a cheaper cost, power independent, applicable for use in younger women, and could be the practical solution for developing countries.



*The BreastLight –First generation  
The Breast-I Fourth generation*



*Collaboration with Pledge Pink of UT Bank - Mobile breast screening van*



*Cape Coasters walking for breast cancer awareness*



### *Hepatitis B Virus Infection in Pregnant Women in Ghana: Effects of Pro-Inflammatory Antiviral Activity on Successful Pregnancy*

This study aims to examine the immunopathogenesis of HBV infection in pregnant women by understanding the physiological and immunological changes during normal and pathological pregnancies in the Cape Coast Metropolis. Also, the prevalence of HBV among pregnant women, as well as recurrent spontaneous abortions associated with HBV infection in pregnant women, will be estimated. This survey will investigate 60 pregnant women, who are in their respective trimesters. These pregnant women will be grouped into two; 30 HBV infected mothers and 30 mothers with no history of HBV exposure. Twenty (20) non-pregnant women will also be enrolled to serve as control. Standardised questionnaires will be administered to each respondent in order to obtain some demographic details, which include birth history (history of RSM or preterm labor) and post-exposure prophylaxis. Serum samples will be taken from all respondents and screened for HBsAg/HBeAg. HBV positive samples would be confirmed by PCR technique. Samples will also be screened for levels of Th1 cytokines; IFN- and TNF- using the Enzyme Linked Immunoassay (ELISA) technique. Statistical analysis will be performed on the data and results obtained from the study with the aim of correlating test results to the data collected. The study is expected to reveal the influence of pro-inflammatory Th1 cytokines on different trimesters of pregnancy in women in association with Hepatitis B infection. This will be helpful in the management of pregnancy in women who are infected with Hepatitis B virus in Ghana.

### *Immunological Profile in HIV Infected Pregnant Women Visiting the Cape Coast Teaching Hospital in Ghana*

The purpose of this study is to examine the effect of HIV infection on the immune response in pregnant women in the Cape Coast Metropolis. This involves determining and comparing the viral load in HIV infected pregnant and non-pregnant women throughout pregnancy and the post delivery period. It will also measure immunoglobulin levels in the plasma of HIV infected pregnant, HIV infected non pregnant, HIV uninfected pregnant and HIV uninfected nonpregnant women and lastly, compare the Th1 and Th2 cytokines levels in the plasma among these groups. The study will be carried out in the Cape Coast Metropolis. Women attending antenatal clinics and screened for HIV will be recruited for the study. Determine rapid test (Abbott Laboratories, IL, and USA) will be used to screen for HIV. All reactive and doubtful samples will be confirmed with the Western Blot test. Five milliliters of blood will be requested from 30 HIV-1 infected pregnant women and 30 of pregnant women who are not infected with HIV as approved by ethical committee. Five mls of blood will also be requested from 30 healthy HIV-positive non-pregnant women and 30 HIV-negative non-pregnant women. Plasma will be separated from whole blood and the lymphocytes subset will be determined immunologically by measuring the various subsets of T cells by commercial kits that stain for CD3+, CD4+, CD45RO and CD8+ T cell markers using flow cytometry to identify the different subsets of T lymphocytes. The cytokines gamma interferon (IFN- $\gamma$ ), TNF- $\alpha$  and interleukin-4 (IL-4) and IL-10 will be measured. RNA viral load will also be determined by quantitative reverse-transcribed Polymerase Chain Reaction (PCR) of the long terminal repeat (LTR) sequence of HIV-1 in the infected children in which the test samples are quantified by comparison with a standard curve. The standard curve was generated from tissue culture supernatant virus (U455) strains of HIV-1 and CBL23 strain of HIV-2 in 8166 cells. The levels of IgGs will also be measured by ELISA. Differences between groups will be evaluated by Student's t test using Statview software (Abacus, Berkeley, Calif.) and p values of <0.05 will be considered significant. Analysis of variance (ANOVA) with Bonferroni correction will be used to compare means of the cytokines levels that will be measured between and within the two groups. Log transformed viral load data from the two groups will also be compared. Correlation between the log transformed viral and the cytokine levels will also be carried out. The immunological profile in pregnant HIV infected patients will provide more knowledge about HIV treatment to avoid mother-to-child transmission.





### ***Body fat, non-alcoholic fatty liver disease and cardiovascular risk among patients at the Cape Coast Teaching Hospital, Cape Coast, Ghana***

Conceived as an interdisciplinary medical research project bringing together basic, paraclinical, clinical and community medicine professionals from two teaching hospitals, this research project focused on the emerging condition, non-alcoholic fatty liver disease (NAFLD), and sought to expand the body of evidence to include the situation in Ghana. The research, among other things, measured the prevalence of the condition in a tertiary care facility in Ghana. It investigated the epidemiology of the condition and assessed the relationship between the condition and various cardiometabolic risk factors. The project assessed the validity of non-invasive methods such as the fatty liver index for the detection of NAFLD in the Ghanaian population.

The project provided clinical research data collection exposure for medical officers enrolled in postgraduate training (residency) at the Cape Coast Teaching Hospital. A presentation on the topic "Non-Alcoholic Fatty Liver Disease" was made to the maiden International Scientific Conference of the Ghana Association for the Study of Liver, Intestinal and Digestive Diseases (GASLIDD) in Kumasi, Ghana. A publication summarising the findings of the research project is in its final stages.

### ***Trial for the Reduction of Infant Undernutrition through Modified Feeding (TRIUMF)***

The objective this study was to examine the effect of providing a macro- and micro-nutrient fortified complementary food supplement (KokoPlus™) on growth and nutritional status of Ghanaian infants. In a single blind cluster randomized study design, a total of 38 communities with population >1000 (Of 61 communities in 3 Districts) were randomly allocated to three intervention arms: (KokoPlus™ Group)

KokoPlus™ and nutrition education, (Micronutrient Group) Micronutrient powder and nutrition education, (Nutrition Education Group) Nutrition education alone (n=301 per group). A&B intervention groups received the same micronutrient dosage with macronutrient and amino acid enrichment only in the A supplement. In all three intervention arms, monthly nutrition education sessions emphasised breastfeeding, appropriate complementary feeding, water, hygiene, and sanitation as well as recipe demonstrations. Infants were recruited when they attained 6 months and baseline data (B) collected following informed consent with midline (M) and endline (E) at 12 months and 18 months respectively. Data

included dietary intake, socio-economic characteristics, morbidity, water, hygiene and sanitation practices, food security at B, M and E, anthropometric data monthly and morbidity and compliance weekly. A venous blood draw (< 5ml) was collected at baseline (6 months of age), midline (12 months of age) and endline (18 months of age). Length for age (LAZ), Weight for age (WAZ) and Weight for height (WLZ) Z-scores were computed using the 2006 WHO growth reference. Micronutrient biomarkers assessed include serum haemoglobin, serum retinol binding protein, serum ferritin and serum zinc, inflammation markers included C-reactive protein and alpha glycoprotein and growth markers included serum IGF-1 and serum cortisol. This project helped to improve the capacity of the laboratory staff. It also brought us in close contacts with a lot of the communities in the region which will help in future studies.

### ***Molecular Epidemiology of Rotavirus in Children under Five in Africa***

Group A human rotaviruses (RVA) are the most common causes of severe viral gastroenteritis in infants and young children worldwide. The available vaccines, while effective in Europe and North America, have shown a reduced efficacy in Africa. One issue raised was the genetic variability of RVA. This review provides a comprehensive view of the current circulating rotavirus strains in Africa, which can be important in light of the new rotavirus vaccinations. Indeed, in Africa, the pursuit of national and continental studies for epidemiological surveillance of circulating rotavirus strains is vital for the promotion of future successful vaccines.

### ***Haematological and Biochemical Changes in Patients at the Antiretroviral Therapy Clinic***

Human immunodeficiency virus (HIV) infection is associated with a wide range of haematological disorders such as anaemia, leucopenia, thrombocytopenia and AIDS-related lymphoma. The HIV infection is also associated with adverse biochemical events such as abnormalities in protein, glucose and lipid metabolism especially during antiretroviral therapy (ART). This study, therefore aims at determining the haematological and biochemical changes in HIV patients and it's correlation with CD4 cell counts. The study will be conducted at the antiretroviral therapy (ART) clinics in the Cape Coast Metropolitan Hospital (CCMH) and the Cape Coast Teaching Hospital (CCTH) in the Central Region of Ghana. The outcome of the study would lay the framework for further improvement and comprehensive care to minimize known abnormalities associated with the disease progression.

Quinolone Resistance (qnr) Genes in Fecal Carriage of Extended

### **Spectrum Beta-Lactamases Producing Enterobacteria Isolated from Children in Niger**

*Qnr* genes are known to confer a low level resistance to fluoroquinolone in *Enterobacteriaceae*. Their presence with other antibiotic resistance mechanism as extended spectrum  $\beta$ -lactamase (ESBL) on the same plasmid are common and can spread widely. This study aimed to detect the presence of *qnr* genes in ESBL-producing commensal *Enterobacteriaceae* in 443 children aged 6 to 59 months included in a clinical trial conducted by Doctors without Borders/Epicentre at Maradi, Niger. This is the first identification of *qnr* genes in ESBL producing commensal *E. coli* and *Klebsiella spp* in children without antibiotic therapy in the seven precedent days in Niger. These genes could be involved in the resistance to quinolones in Niger.

### **Retinal Microvasculopathy in HIV/AIDS at CCTH, Ghana**

The purpose of this study was to evaluate the ocular disorders in HIV positive patients attending the CCTH, Ghana. Of the 295 participants, 205 (69.5%) were on antiretroviral therapy while 90 (30.3%) were not on therapy. A majority of the participants (162,

54.9%) were in clinical stage two, followed by stages three (68, 23.1%), one (62, 21%), and four (3, 1%), respectively. The overall prevalence of ocular disorders was 5.8%. The most common HIV related ocular disorder was HIV retinal microvasculopathy (58.8%), followed by herpes zoster ophthalmicus and Toxoplasma retinochoroiditis, both representing 11.8% of ocular disorders seen. Cytomegalovirus retinitis, Bell's palsy, and optic neuritis were the least common (5.9%). CMV retinitis recorded the highest viral load of 1,474,676 copies/mL and mean CD4 count of 136 cells/mm<sup>3</sup>. The mean CD4 count for participants with HIV related ocular disorders was significantly lower compared to participants without disorders ( $t = 2.5, p = 0.012$ ). Participants with ocular disorders also recorded significantly higher mean viral loads than those who did not have ocular disorders ( $t = 2.8, p = 0.006$ ). Lower CD4 counts and high viral load copies were associated with the manifestation of HIV related ocular disorders.



### ***Prevalence of Hepatitis Virus Delta Infection among HBVAg Positive Blood Donors at the Regional Blood Transfusion Centre of Ouagadougou, Burkina Faso***

Infection with hepatitis viruses constitutes a public health problem in Burkina Faso. Previous studies have estimated the prevalence of viral hepatitis A, B and C. This study aimed to study the prevalence of Hepatitis Delta Infection in apparent healthy blood donors positive for the antigen of hepatitis B virus. This study shows that 97.5% of HBsAg positive person detected by the ARCHITECT i1000 SRTM were positive by PCR. The obtained results showed that the distribution of HDV in blood donors positive for the Hepatitis B antigen was low (0.5%).

### ***APOBEC3G Variants and Protection against HIV-1 Infection in Burkina Faso***

Studies on host factors, particularly the APOBEC3G gene, have previously found an association with AIDS progression in some populations and against some HIV-1 strains, but not others. Our study had two main objectives; firstly, to screen a population from Burkina Faso for three variants of APOBEC3G previously described, and secondly, to analyze the effects of these three variants and their haplotypes on HIV-1 infection with Circulating Recombinant Forms (CRFs) present in Burkina Faso. This study demonstrates an association of rs6001417, rs8177832, and rs35228531 of APOBEC3G with HIV-1 infection in a population from Burkina Faso.

### ***Challenges associated with Disclosing HIV Status to Sexual Partners in Ghana***

Encouraging disclosure within a trusting and supportive environment is imperative in dealing with HIV/AIDS related stigma. However, disclosure rates and the factors that influence it are vaguely understood in African societies. This study aimed at determining the disclosure rate and factors that influence disclosure in Cape Coast, Ghana. This study suggested that the existing support services ill prepares newly diagnosed HIV positive clients and hampers disclosure initiatives. Providing comprehensive support services and re-training peer educators may be crucial in creating a safe disclosure environment in Ghana.

### ***Genetic Diversity of Toxoplasma gondii Isolates from Africa***

The genetic diversity of Toxoplasma gondii (*T. gondii*) population varies from one geographical area to another. The majority of *T. gondii* isolates in North America and Europe are types II and III.

In South America no clonal or atypical genotype is dominant. In Asia, the atypical ToxoDB# 9 and clonal type I are dominant. Very few studies on Toxoplasma genotypes have been done in Africa. The available information is from Northern, Western, Eastern and Central Africa. The aim of this study was to analyse and highlight the population genetic structure of *T. gondii* isolates circulating in Africa revealed by multi-locus PCR-RFLP and microsatellite typing. The available information indicates that, both archetypical and non-archetypical populations of *T. gondii* occur in Africa and infection caused by archetypical genotype of *T. gondii* is very high in both human and animal population from Africa.

### ***Epidemiology of Human Papillomavirus among HIV Positive Women Compared with HIV Negative Women, Ghana Project***

a. There is limited data in Ghana on the epidemiology of HPV and cervical neoplasia and their associations with HIV. This study aimed to compare among HIV-1 seropositive and HIV-seronegative Ghanaian women. The issues were:

1. the prevalence, genotype distribution and risk factors associated with cervical HPV infection;
2. the prevalence and risk factors associated with cervical squamous intraepithelial lesions (SIL); and
3. the incidence, persistence, regression and progression of SIL over a 6-month period. This concluded that HIV-1 infected women bear significant burden of HPV infection and related disease. Prevention and screening programmes should be specifically deployed for this population in Ghana.

b. Modern cervical cancer screening increasingly relies on the use of molecular techniques detecting high-risk oncogenic human papillomavirus (hr-HPV). A major challenge for developing countries like Ghana has been the unavailability and costs of HPV DNA-based testing. This study compared the performance of careHPV, a semi-rapid and affordable qualitative detection assay for 14 hr-HPV genotypes, with HPV genotyping, for the detection of cytological cervical squamous intraepithelial lesions (SIL). The performance characteristics of careHPV compared to genotyping suggested that this simpler and cheaper HPV detection assay could offer a suitable alternative for HPV screening in Ghana.

c. Detection of genital HPV DNA is recommended as an important strategy for modern cervical cancer screening. Challenges include access to services, the reliance on cervical samples taken by clinicians, and patient's preference regarding provider gender. The objective of this aspect was to determine the acceptability, feasibility, and performance of alternative self-collected vaginal



samples for HPV detection among Ghanaian women. The feasibility, acceptability and performance of SC using careHPV supported the use of this alternative form of HPV screening among Ghanaian women. This could be a potential new affordable strategy to improve uptake of the national cervical cancer screening programme.

### ***Epidemiology of Human Papillomavirus among Women, Burkina Project (Summary from Some Specific Studies)***

a. Human Papilloma Virus (HPV) infection remains a worldwide concern, especially in Sub-Saharan Africa where cervical cancer is the leading cause of cancer death in women. The aim of the study was to determine the prevalence and genotypic distribution of High-Risk HPV (HR-HPV) involved in Cervical Intraepithelial Neoplasia (CIN) II and III and in cervical cancer in Parakou. This study helped to detect (in samples archived, fixed and paraffin-embedded tissues) HR-HPV involved in high-grade precancerous lesions and in cervical cancer in Parakou, some of which are not covered by currently available vaccines.

b. High-risk human papillomavirus (HPV) is found in over 99% of cervical cancers. The aim of this study was to determine the prevalence of HPV in a population of women in Bobo-Dioulasso and to identify the high-risk types present in these women. This type of study, which is the first one in Bobo-Dioulasso, has showed a high prevalence of genotypes HPV 39, HPV 52, and HPV 35 which are not yet covered by a vaccine.

c. We aimed at identifying the high-risk HPV genotypes associated with high-grade dysplastic cervical lesions in Burkina Faso. The available vaccines to Burkina Faso, only protect against two high-risk HPV genotypes: HPV 16 and 18. Are the genotypes identified in the high-grade precancerous lesions in this survey covered by the available vaccines? We noted a high prevalence rate for HPV 39, HPV 35 and HPV 45, which are not covered by the commercial vaccines. We also found that the prevalence of HPV 18 was very low in this study and HPV 16 was not detected.

### ***Effects of Falciparum Malaria on Levels of Selected Biomarkers of Cardiovascular Disease Risk in Type 2 Diabetics and Non-diabetic Controls***

This work, which started in 2011, aimed at investigating the role that malaria plays in the pathogenesis of type 2 diabetes mellitus and its associated complications in diabetes patients and controls in the Cape Coast Metropolis. It involved the recruitment of over 250 diabetic and control respondents who were followed for symptomatic malaria episode over a period of two years. Selected biomarkers of cardiovascular disease risk such as lipid profile, leptin,

adiponectin, C - reactive protein, lipid peroxides, total antioxidants capacity, insulin resistance and beta cell function were assessed in respondents before and during Plasmodium *falciparum* malaria. Anthropometric indices such as body mass index, waist-to-hip ratio and total adiposity index were also measured before and during *falciparum* malaria.

Findings from the study suggested that *falciparum* malaria increased the cardiovascular disease risk of affected individuals independent of adiposity through elevated inflammation, peroxidation, insulin resistance and abnormal lipid profile. In addition, total antioxidant capacity and beta cell function declined during *falciparum* malaria. These observations imply that *falciparum* malaria does not just increase cardiovascular disease risk of respondents but also increase the risk of non-diabetic respondents to the development of type 2 diabetes mellitus especially due to the possibility of multiple episodes of malaria in one's lifetime. This makes malaria a risk factor for the development of type 2 diabetes development in our setting.



***Diabetes Research Group at Department of Biochemistry, UCC School of Medical Sciences***

### ***A study of Insulin Resistance in Rat Malaria***

This work, which was a follow-up from an earlier one in humans, sought to investigate the likely effects of multiple episodes of malaria on insulin resistance as well as the nature of malaria-induced insulin resistance in Sprague Dawley rat. The work was sponsored with GHC15 000 by DRIC, UCC. It involved about 140 adult Sprague Dawley rats which were divided into four broad groups; malaria only, type 2 diabetes only, type 2 diabetes plus malaria, and neither malaria nor diabetes. Malaria was induced by *Plasmodium berghei* and type 2 diabetes by intraperitoneal administration of 60 mg/kg STZ dissolved in ice cold 0.1 M citrate buffer fifteen minutes after the intraperitoneal administration of nicotinamide (120 mg/kg dissolved in normal saline). Blood glucose, insulin resistance and beta cell function were assessed before, during and after *Plasmodium berghei* infection. Animals were treated pharmacologically before being subjected to a second bout of *Plasmodium berghei* infection.

Findings from this work confirm that mild *Plasmodium* infection is a risk factor for development of type 2 diabetes mellitus through insulin resistance. Also, malaria-induced insulin resistance though transient, appears to establish some memory that primes affected cells to heightened insulin resistance even at reduced parasitaemia. Above all, parasitaemia increased with insulin resistance irrespective of episode of infection

### ***Elucidating Determinants of Type 2 Diabetes Mellitus Predisposition in the Cape Coast Metropolis of Ghana***

Development of type 2 diabetes mellitus is a gradual process involving genetic and environmental factors, which work together to prime the individual to full-blown diabetic condition. Interestingly, the genetic factors are only expressed under suitable environmental conditions. Yet, scientific information on the specific environmental determinants that pre-dispose an individual to the development of type 2 diabetes mellitus in the Cape Coast metropolis are unknown. This study, therefore, sought to investigate the prevalence of pre-diabetes in the Cape Coast Metropolis and to identify specific environmental factors that contribute to type 2 diabetes predisposition so as to devise a rationale strategy to arrest the high spate of the condition in the Ghanaian populace in general and the Cape Coast Metropolis in particular. The field and laboratory works have been completed and the acquired data are being analysed for further action.

### ***Sero-epidemiology of Hepatitis B among Children of the Cape Coast Metropolis***

The World Health Organisation (WHO) recommends universal vaccination for children against Hepatitis B infection due to its huge public health impact on the wellbeing of mankind. To assess the impact of the implementation of this recommendation in the Cape Coast Metropolis, the current study was designed to investigate the prevalence of Hepatitis B infection in children in the Cape Coast Metropolis. Field and laboratory works have been completed and the obtained data is being analysed for further action.

### ***Hepatitis B profile of Blood Donors at CCTH***

Blood transfusion is a life-saving treatment option given to individuals especially in emergency health conditions. Such treatment is only made possible through the benevolence of blood donors. However, this life-saving gesture can also become a major avenue for disease transmission if not properly screened. This study, therefore, aimed at investigating the Hepatitis B profile of individuals who donated blood at the Cape Coast Teaching Hospital from June, 2014 to September, 2016. The work is at the data analysis stage.

### ***Hepatitis B and C Co-infection in Newly Diagnosed HIV Patients***

Individuals infected with the Human Immunodeficiency Virus (HIV) are at increased risk of infection by other infectious agents such as the Hepatitis virus. Indeed, coinfection of HIV and Hepatitis B or C or both triples the risk of liver-related pathologies. As a result, information on such coinfections is critical for effective management of HIV cases and its related pathologies in our setting. It is in the light of this that the current study is being undertaken to determine the prevalence of Hepatitis B and C infections in newly-diagnosed HIV patients attending the HIV Clinic at the Cape Coast Teaching Hospital. The study, which is on-going, is funded from the personal resources of the investigators. It is envisaged that, reliable prevalence data on HIV-hepatitis coinfection and associated risk-factors will be obtained to guide effective management of HIV cases and allow for adoption of a rational preventive strategy to minimise the spate of coinfection in our setting.

### ***The Role of Gut and Saliva Microbiome in the Progression of Liver Cirrhosis***

The Swedish Research Link awarded the grant for the execution of the gut and saliva microbiome study in Sweden and Ghana. This study will bring to light the role of the gut and saliva microbiome in the progression of Liver Cirrhosis and Hepatocellular carcinoma.

### *Sickle Cell Disease and Other Haemoglobinopathies in Infants Aged Six Months and Above Attending CCTH Child Welfare Clinic (CWC)*

This research has the objective of determining the haemoglobin types of infants attending the CWC of the CCTH in order to offer counseling and early management with resultant improved health outcomes for those found to have sickle cell disease. The information gained will help policy development for early detection and management of the disease; as well as provide a cohort for further research. With the attendance at the CWC, it is expected that the researchers would be able to get reasonable numbers and complete the project in 2 years.

### *Sickle Cell Day Celebration*

The Department celebrated 19th June - Sickle Cell Day, over 3 days with educational talks, seminars and marches in Cape Coast and Accra amongst patients, colleagues and the public. We were on radio stations and TV stations as well as public squares. The objective was to spread knowledge about the disease. The worldwide theme was **EXHIBIT COURAGE, ADDRESS INEFFECTIVE AREAS OF SUPPORT**. We had a simpler version of **I HAVE SICKLE CELL: I AM NOT AFRAID**. The celebration was very successful, thanks to a good motivated team and sympathetic donors. We hope to continue this yearly.



*The Haematology Team of Doctors during the Sickle Cell Day Celebration at the CCTH, Ghana*

### *Professional Training Workshop “The Nursing Process: A Tool for Evidence-based”, Held 10th April, 2015 at the School of Medical Sciences Auditorium, UCC*

The Department of Adult Health Nursing, under the auspices of the School of Nursing and Midwifery (SoNM) organised a full day maiden workshop on the theme, “The Nursing Process: A tool for Evidence-based”, on the 10th of April, 2015, at the School of Medical Sciences (SMS) auditorium. The short but intense workshop, which was sponsored by the SoNM, saw over 100 participants in attendance. The participants were made up of nursing students, SoNM faculty members, and forty-one clinicians drawn from six healthcare institutions within the Cape Coast Metropolis. The Organising Committee comprised SoNM faculty, led by Mrs. Christiana Ocantey, the Coordinator.

The purpose of the workshop was to provide up to date knowledge in nursing to nurses in the clinical setting on the nursing process and to encourage them to apply it to care. It was also to sharpen the skills of nursing students on the use of the nursing process. The workshop also afforded an enhanced relationship between the department and staff of the various healthcare facilities where UCC nursing students undergo clinical nursing practice experience.

A presentation on the theme was delivered by the resource person, Ms. Hannah A.O. Acquah (Vice President - Ghana College of Nurses and Midwives) after which participants were organised into groups to work on various cases. The group sessions were coordinated by the SoNM faculty. After the larger group had re-convened, the leaders from the various breakout groups presented their assigned cases and the resource person, together with faculty, effected the necessary corrections.

This being the maiden institutional collaborative workshop organised by the department, it was very well rated as very timely. This was because the content of the materials/delivery was highly important and needed, and the facilitation was rated excellent. Most of the participants however, indicated that the duration was too short and recommended that future workshops should be organised for at least two days and should also include tutors from the Nursing Training Institutions. Certificates of participation were also awarded to all participants.



### ***Professional Training Workshop and Public Lecture on Mental Health and Substance Use Disorders, Held 16th, 19th, and 21st June, 2015, at UCC and the Accra Psychiatric Hospital***

The Department of Mental Health, SoNM of CoHAS, UCC, in collaboration with the University of South Florida organised a public lecture and a day's professional training workshop. This took place at two different locations, that is (UCC and the Accra Psychiatric Hospital, respectively on the 19th and 21st June, 2015. Both activities were well attended. The university community, represented by various faculties, greatly benefitted from the public lecture. The two workshops brought together over 410 participants comprising mainly mental health practitioners (Nurses and Psychiatrists) and educators from Mental Health Institutions across the country. The team was led by a Fulbright scholar, Prof. Roger Peters (a clinical psychologist) from the University of South Florida. The two workshops were preceded by a public lecture delivered by Prof. Roger Peters, on 16th June, 2015, on the theme, "New Advances in Treating Substance Abuse Problems". The public lecture highlighted new research-based interventions to identify and treat persons with substance abuse problems. These included the use of specialised screening and assessment instruments to detect substance use disorders, treatment curricula that focus on building cognitive and behavioural skills, contingency management programmes, motivational interventions, relapse prevention, and use of peer support as well as self-help groups.

The training workshop reviewed the importance of identifying and treating substance abuse problems among Psychiatric Hospital patients. Participants were taken through several effective techniques for screening, assessment, and treatment of co-occurring mental and substance use disorders, different methods for structuring hospital services for patients who have co-occurring disorders, unique characteristics of patients who have co-occurring disorders and challenges in working with this patient population. The seminar also addressed different approaches to providing services to co-occurring disorders in psychiatric hospitals. Exercises included use of clinical case studies to explore challenges presented by patients who have co-occurring disorders, and how to develop treatment planning strategies.

A presentation on the theme was delivered by the resource person, Prof. Roger Peters after which participants were organised into smaller groups to work on various cases. The group sessions were coordinated by Dr. Jerry Ninnoni (Head of the Mental Health Department - SoNM, UCC). After the larger group had re-convened,

the leaders from the various breakout groups presented their assigned cases and the resource person, together with faculty, effected the necessary corrections. Skills addressed in the training were how to identify/screen for substance use disorders, tips for conducting a comprehensive assessment for co-occurring disorders, and how to identify effective treatment services for patients who have co-occurring disorders.

Overall, the two programmes which were well attended were deemed very timely, the content highly important and needed, and the facilitation was excellent. Certificates of participation were awarded to participants at the end of the workshop.

### ***3rd Mental Health and Well-being International Conference of Ghana, Held 17th-19th October, 2016 at UCC***

The Department of Mental Health Nursing in collaboration with the Mental Health Foundation of Ghana (MHFGH) hosted the 3rd Mental Health and well-being Conference, on the theme, "Dignity in Mental Health --Psychological and Mental Health First Aid for All", took place at the SMS auditorium at the UCC from 17th -19th October, 2016. The conference, which drew over 400 participants from across the country, was well attended by Nurses and Psychiatrists from the three main psychiatric hospitals in Ghana (Pantang, Ankaful and Accra Psychiatry), as well as Mental Health Nurse Educators and students from the Ankaful and Pantang Nursing Training Colleges, the University of Health and Allied Sciences (UoHAS) and UCC.

The conference also brought together experts in mental health education and research, and mental health care delivery, by featuring presenters from Australia, Canada, UK, Nigeria, and Ghana. This provided a rich blend of professional and educational content, which complemented the first rated keynote and plenary speakers, workshops and poster presentations. Consistent with the theme of the conference, there were presentations and workshops on mental health first aid, stigma as a public health challenge, suicide prevention, mental healthcare practices and monitoring, management of forensic patients in prisons, challenges of task-shifting in mental health services in Ghana, as well as lived personal experiences of persons with mental health conditions and their carers. With this conference, the MHFGH and partners contributed to contemporary mental health education in Ghana.

In addition, there was a rich programme of post conference activities. These included a visit to Cape Coast, historical and cultural sites;

mental health field work in Cape Coast; public speaking competition to promote psychiatry, organised by UGMS at the Ghana College of Physicians and Surgeons, Accra, Conference satellite symposium on the Ho Campus of UoHAS. Also, a workshop was run for the Ningo-Pampram District Assemblymen and Health Directorate where the foundation's Mental Health outreach is located.

The keynote lecture, titled, "Public Health Challenges In Mental Health: Stigma", was delivered by Professor Malcolm Hopwood, President of the Royal Australian and New Zealand College of Psychiatrist (RANZCP). The plenary speakers were Professor Vincent Agyapong (Consultant Psychiatrist, Alberta Health Services; Edmonton Zone Clinical Section Chief, Canada), Dr. Aishatu Yusha'u Armiya'u (Head of Forensic Psychiatry, Jos University Teaching Hospital; Consultant Psychiatrist in charge of Jos Maximum Security Prison, Plateau State, Nigeria), and Dr. Patrick Amoateng (Pharmacist, Pharmacologist;

Senior Lecturer, University of Ghana). The programme, among other things, also included a panel on "Understanding the effects of stigmatisation of mental illness on patients and mental health nurses, which featured 3 key presentations by three UCC alumni. The conference was well rated and certificates of participation were awarded to participants.

The conveners of the conference were Mr. Francis Acquah (MHFGH), Professor Chris Kewly (University of Newcastle, Australia), Mr. Noah Boakye Yiadom (Health Promotion Coordinator, Canada), Ms. Grace Owusu Aboagye (Pharmacist, Ghana) and Dr. Jerry Ninnoni (Department of Mental Health Nursing, UCC).



Participants at the "Mental Health and well-being" conference during the registration (photo credit: Timeline Photos).



The Administrative support from the Mental Health Department, School of Nursing and Midwifery, UCC led by the Head of Department - Dr. Jerry Ninnoni (4th from right) (photo credit: Timeline Photos).



The keynote speaker, Professor Malcolm Hopwood, President of RANZCP (1st from left) and Mr. Francis Acquah, the president of the MHFGH (middle) with some Delegates at the "Mental Health and Well-being" International Conference (photo credit: Timeline Photos).



Mr. Francis Acquah (3rd from the left) and some of the plenary speakers; Professor Vincent Agyapong (1st from right), Dr. Aishatu Yusha'u Armiya'u (2nd from left), being introduced during the opening of the conference (photo credit: Timeline Photos).



A section of the participants of the conference during one of the sessions (photo credit: Timeline Photos)



Mr. Francis Nii Lanteye Acquah, the president of the MHFGH delivering his "President's Message" during the opening of the conference (photo credit: Timeline Photos)



A section of the Board Members/International Directors of the MHFGH (photo credit: Timeline Photos)



Dr. Akwasi Osei (Left), the CEO of the Mental Health Authority of Ghana making a presentation to the Queen Mother Nana Mbroba-Dabo I (2nd from right), the Patron of Mental Health Foundation Ghana, during the conference (photo credit: Timeline Photos)



A section of the participants of the conference during one of the sessions (photo credit: Timeline Photos)



***The Yale Alumni Service Programme “Helping Babies Breathe”, Held 8th-9th August, 2016 at the School of Nursing and Midwifery, UCC***

The Maternal and Child Health Department of at SONM hosted and coordinated a training workshop on “Helping Babies Breathe (HBB) and Essential Care for Every Baby (ECEB)”, from the 8th to the 9th of August 2016. Two short, but intense, courses were sponsored by the Yale Alumni Service which saw 15 participants in attendance. Four facilitators of the Yale Alumni team, led by Dr. David Bergman led participants in a discussion. The participants were made up of seven nursing students, two SONM faculty members, and six Midwifery Clinicians drawn from three health institutions within the Cape Coast Metropolis.

The workshop, which was originally scheduled to last three days, was facilitated within two days because participants had the basic knowledge needed and therefore no time was spent on preparing aspirants. On day one of the workshop, participants were taken through various topics, which included; an overview of the HBB and ECEB course, preparation for birth and routine care, care during the golden minute, continued ventilation with normal, and slow heart rate. Day two started with a review of the activities of the previous day followed by the day’s topics in ECEB such as essential care in the first 90 minutes of life, essential care for a new baby, essential care of a baby with a temperature or feeding problem, and assessment for danger signs. In addition various case studies were used to provide opportunity for participants to apply the knowledge acquired in a more practical way. There were demonstrations and return demonstrations to facilitate skill acquisition. At the end of the workshop, all participants were presented with a certificate of participation. The facilitators presented eight HBB kits and literature on ECEB to the School of Nursing and Midwifery to enhance effective teaching of HBB and ECEB courses.



***Project participants in a photo pose with the Yale Alumni team at the Clinical Skills Lab, School of Nursing and Midwifery, UCC (photo credit: Mrs. Evelyn A. Ampofo).***

***Dr. David Bergman, leader of the project, giving a pre-skills performance instruction at the simulated clinical setting (photo credit: Mrs. Evelyn A. Ampofo).***



*Yale Alumni team members observing participants performing resuscitation of helpless neonates in a simulated clinical skills laboratory, UCC (photo credit: Mrs. Evelyn Ampofo).*

***Workshop on “Nursing and Midwifery Education and Practice in Ghana; Looking Backwards and Planning for the Future”, Organised by the Department of Adult Health, School of Nursing And Midwifery, UCC, Held, 28th and 29th September, 2016***

The Department of Adult Health of SoNM, UCC, organised a two-day non-residential workshop on the theme **“Nursing and Midwifery Education and Practice in Ghana; looking backwards and planning for the future”**, from the 28th to the 29th of September, 2016. The workshop recorded 168 registered participants from various health facilities within Central Region, mainly from Cape Coast and its immediate environs to be precise. The participants comprised Nursing and Midwifery Clinicians, Faculty Members of the SoNM/UCC, Nurse educators from other schools, as well as students from the School of Nursing, UCC (both undergraduate and post graduates). The workshop also brought together expertise in Nursing practice, education and research in Ghana, by featuring resource persons such as Mr. Felix Nyante (The Registrar, Nursing and Midwifery Council (N&MC) of Ghana), Dr. (Mrs.) Jemima Dennis Antwi (The President - Ghana College of Nurses and Midwives (GCNM), Mrs. Sophia Blankson (The Nurse Manager, Cape Coast Teaching Hospital), and Mrs. Evelyn Asamoah Ampofo (The Coordinator, Department of Maternal and Child Health, SoNM, UCC). This provided a rich blend of professional and educational content for the workshop.

Addressing the theme, the keynote speaker, Mrs. Evelyn A. Ampofo, stressed the importance of mentoring students by Clinical Nurses. She encouraged all nurses to be proud of their profession and engage in acts that only put the image of the noble profession in a positive light. In her presentation, Mrs. Blankson stressed best clinical practices through right attitudes, continuous professional education, and evidenced-based practices.

Mr. Felix Nyante elaborated on the role of N&MC in regulating nursing education and practice, the upsurge of nursing schools in the country as well as its effect on the quality of nursing education, and the contribution of training institutions to graduate nurse unemployment. He suggested some form of consultative forum between prospective employers and nursing training institutions on the number of students to be trained in a year to reduce the rate of unemployment among graduate nurses. He also encouraged nurses to write articles that can be published in the NUMID Horizon Journal (a peer reviewed journal introduced by the N&MC).

Dr. (Mrs.) Jemima Dennis Antwi, gave a detailed history of nursing in Ghana from the pre-colonial era to the modern day of specialisations, highlighting the myriad of problems associated with each block of transition, and their effects on nursing. She introduced participants to the GCNM, highlighting the various specialisation programmes being offered and how nurses can join the college with the requisite qualification. She proposed a possible affiliation with some Universities in Ghana to do a content review of the college’s curriculum so that residents can graduate with their Membership, specialisations and Master’s degrees.

There were plenary discussions where participants were divided into seven groups. Each group discussed extensively a number of issues affecting contemporary nursing. Heads of the groups presented their findings which generated lively contributions as well as constructive criticisms. The resource persons and faculty made relevant inputs during the discussions.

Interviews conducted at the end of the workshop indicated participant satisfaction with the content gained from the workshop. Most participants said the programme was very useful and had improved their knowledge and skills in nursing practice. They suggested that the school should often organise more of such educative workshops to keep them abreast with happenings within the profession. Participants were awarded with certificates of participation.

### ***Collaborative Research Projects Involving the Mental Health Department, School of Nursing and Midwifery***

1. Designed as an inter-institutional collaboration between the two Universities, the Department of Mental Health, School of Nursing and Midwifery, under the leadership of Dr. Jerry Paul Ninnoni (the Head), is working together with Prof Roger Peters, (Head, Department of Mental Health Law and Policy-University of South Florida), on an ongoing research on "Substance Use Disorders and Treatment Modalities among psychiatric patients in Ghana". The focus includes prevalence, assessment and identification of patients with co-occurring mental health and substance use disorders and treatment approaches in the mental health hospitals. The project which began in the third quarter of 2016 is expected to end by the end of the 2nd quarter of 2017.
2. Dr. Jerry Paul Ninnoni (Head, Department of Mental Health - SoNM, UCC) has teamed up with Tristan Hansell and Dr Lisa Brown (Palo Alto University, California) in a collaborative research on 'Using Photovoice to Gain Perspective of Risks and Protective Factors in Refugee Communities in Ghana'. The focus includes understanding impeding contributory factors associated with positive and negative mental health outcomes among refugee populations. The project which began in January 2017, involves data collection partly from Ghana as well as the USA.

### ***"Medical Ethics Today"- April, 2015 at the University of Cape Coast Hospital and the Cape Coast Teaching Hospital***

The Department of Medical Laboratory Sciences in the School of Allied Health Sciences (SAHS), in conjunction with the University of Cape Coast Health Services (UHS, UCC), and the Cape Coast Teaching Hospital (CCTH), organised a workshop on the theme "Medical Ethics Today", in March 2015. The workshop, which targeted staff of the UHS/UCC and medical laboratory staff of the CCTH, highlighted the need for all categories of staff to uphold high standards of ethical practices in all spheres of healthcare delivery. In the CCTH, staff from the Department of Laboratory Services were enlightened on ethical issues confronting the department's services delivery and how to address such issues.

### ***Application of Six Sigma Metrics for the Assessment of Quality Control in Clinical Chemistry Laboratories - April, 2015 at the UCC Hospital and the Cape Coast Teaching Hospital***

The Department of Medical Laboratory Sciences in the School of Allied Health Sciences (SAHS) in collaboration with the University of Cape Coast Health Services (UHS, UCC) and the Cape Coast Teaching Hospital (CCTH), organised a workshop on the theme "Application of Six Sigma Metrics for the Assessment of Quality Control in Clinical Chemistry Laboratories", in April 2015. The workshop, which targeted medical laboratory staff of both the UHS/UCC and CCTH, highlighted the need for all categories of staff on external quality assessment protocols, advantages and the relevance of Total Quality Management in everyday practice.

### ***The Yale Alumni Service Programme "Medical Screening Outreach " - August, 2016 at the Yamoransa Community***

The Department of Medical Laboratory Sciences in the School of Allied Health Sciences (SAHS) in collaboration with Yale Alumni Medical Service team, conducted a free medical screening and care outreach, for the Yamoransa community in the Central Region of Ghana, in August 2016. The Yale alumni team has adopted Yamoransa as their pet community and thus they organise yearly projects which includes medical screening, ICT training, and eco-business. The week-long project involved screening of metabolic diseases and hepatitis B among the entire adult population. The UCC team were mainly responsible for the screening and then referred those identified with medical conditions to the Yale Alumni Medical team for further assessment and management. Overall, the project was very successful and about 300 inhabitants benefitted from the programme.

### ***Collaborative Research Projects Involving Department of Medical Laboratory Science, UCC and Department of Medicine, University of Toronto, Canada***

The project which began in 2014, involves data that was collected in Ghana solely. The relevance of designing a novel, but easily accessible tool of diagnostic importance, is increasingly becoming important. Microscopy is one of the vital tools in disease diagnosis and public health practice. In a resource limited setting, basic devices are not readily available.



In this study, the team designed the use of mobile phones as hand lenses for use as microscopes in the diagnosis of some parasitic diseases. This technology helped in prompt diagnosis of infections and was cost-effective as well since the mobile phone was easily accessible. The project was successful and the findings were published in peer-reviewed journals.

### *Isobolographic Studies of the Antimalarial Properties of Xylopic Acid and Cryptolepine Combination*

The project was successfully completed in March 2016. The funds from the project were used to purchase a rotary evaporator system, recirculating chiller, a heater, and a pump. The rest were used to purchase experimental animals and reagents. One MPhil student was enrolled in the project. The graduate student is yet to defend his thesis. A manuscript has been submitted to a peer-reviewed journal.

#### *The research objectives were:*

- to determine the curative antimalarial potential (antagonism, additivity or synergism) of xylopic acid and cryptolepine co-administration.
- to study the possible toxicity of xylopic acid- cryptolepine co-administration in vivo in curative model of malaria

#### *The major findings of the work*

The co-administration of xylopic acid and cryptolepine exhibited synergistic antimalarial property. The co-administration was generally safe on the liver and kidney. Sections of the testis of groups of animals co-administered with lower doses of xylopic acid cryptolepine showed normal histology with intact tubules and sertoli cells. There was the presence of normal spermatids and dilation of blood vessels within the epididymis tubules. Contrary, mild oedematous spleen was observed with the presence of hemosiderin in the sections of the negative control animals. These changes were absent in the animals treated with the co-administration.

The future direction of this study is to evaluate the *in vitro* antiplasmodial property of xylopic acid and cryptolepine co-administration using chloroquine susceptible and resistant strains of *P. falciparum*. This will be followed with determination of the mechanism of antiplasmodial property of the co-administration employing in vitro assays.

### *How Visual Crowding Interfere with Stereoscopic Depth Discrimination*

This project investigated aspects of human vision in 3-dimensions (3D). The interest was to understand the influence nearby objects on depth perception. This was a collaborative work between the Anglia Eye and Vision Group, Cambridge and the Optometry and the Optometry and Vision Research Group at the Optometry Department, UCC. The collaboration enabled Dr. Stephen Ocansey, a member of the UCC group write a PhD thesis on the subject. The study focused on the influence of visual crowding on stereoscopic depth perception in normal subjects which was investigated by means of psychophysics. The work was a sequel to the work already developed by Anglia Vision Research, which focused on contour interaction and crowding in 2-dimensional space. The research has been helpful in understanding how humans make judgments about the location of objects and generally, about visual impression of the things humans see in 3D and how this can be applied to advance the understanding of visual impression in the spatial sense. Based on the project results, a new design of the clinical test, used to measure depth perception (stereo acuity) has been suggested, and data from the work are undergoing review for publication in highly recognised journals. Part of the findings had also been presented at American Academy of Optometry Conference held from the 7 - 10th October, 2015 in New Orleans, USA.



*An observer taking part in the experiment in a lab in Cambridge. She is wearing a 3-D goggle to view targets on a computer screen and asked to judge the relative depth of the targets (e.g. does one target appear in front of another) and record her answer by pressing a response button (in hand). The targets could vary from vertical lines in sharp focus to blurry lines and could appear either on their own or surrounded by other targets which make them appear more 'crowded'.*

## *Eye Health Assessment of the Emerging Elderly Population in Ghana*

This project was done in collaboration with the Department of Population and Health, UCC. The project assessed the risk of visual impairment and prevalence of age-related eye diseases and blindness in the elderly population in Ghana using Yamoransa, a peri-urban community near the university as a case study. During the project, all elderly persons aged 60 years and above underwent a complete ophthalmic examination that involved visual acuity, external, and dilated internal examinations. The project found that

visual impairment representing 58.7% and blindness 5.9% were high among the elderly, and even though some were amendable to optical correction, utilisation of eye services were low. The project recommended the need for increased health education, regular eye examination, and the need to subsidize surgical and refractive eye care services for the elderly in Ghana. The outcome of this work has been published to share the information gathered with major stakeholders in Ghana including Health Age Ghana, as Ghana is gradually recording a boom in the elderly population.



*Participants await their turn to be examined by members of the Optometry Research Group (top two pictures). Dr. Stephen Ocansey, a member of the Research Group from the Optometry Department performing an ophthalmoscopic examination on an elderly male participants from Yamoransa (bottom picture). (Note: Pictures have been published with permission)*

## Epidemiology of Systemic and Ocular Toxoplasmosis and their Associations with Polymorphisms in Human Interferon Gamma (IFN- $\gamma$ ) and Tumour Necrosis Factor (TNF- $\alpha$ ) Cytokine Genes

This project was part of the collaboration between the Department of Optometry, Department of Biomedical Sciences, UCC and the Noguchi Memorial Institute for Medical Research. This aspect was specifically designed for Dr Emmanuel K. Abu, a lecturer with the Department of Optometry, to undertake a PhD study. The project which was funded by the University of Cape Coast, through a research grant, sought to determine the associations between interferon gamma/tumour necrosis factor gene polymorphisms and *Toxoplasma* infection (ocular and systemic) in a community-

based epidemiological survey. The project drew participants from urban, suburban and rural communities in the central region to undergo serology testing, ophthalmic examination and genotyping. The project revealed low prevalence of *Toxoplasma* ocular infection in a population of high seropositivity *IFN- $\gamma$  +874T* allele was found to increase the risk of *Toxoplasma* ocular infection whereas *TNF- $\alpha$  -308A* allelic form was found protective. The study recommended to eye care practitioners to be mindful that patients have 50% chance of becoming blind or have over 80% possibility of having low vision. Four papers from this project have been published in international peer reviewed journals. An abstract from the study was also presented at the 14th Awaji International Conference on Infection and Immunity in Awaji, Japan

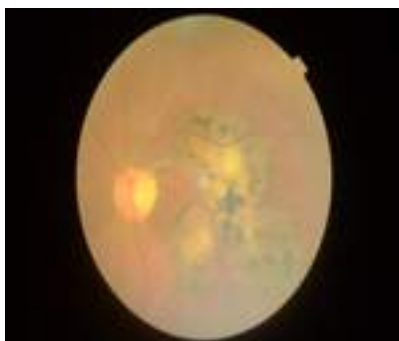

*Toxoplasma scar*



*Toxoplasma scar*

*Fundus photographs taken during the project showing Toxoplasma ocular lesions*





*Dr. E. K. Abu, a member of the Optometry Research group preparing samples and reagents for PCR procedures*

### ***Oculo-visual Disorders of HIV Patients in Ghana***

The project was an interdisciplinary collaborative work between the Departments of Optometry (Dr. E. K. Abu, Dr. S. Abokyi and Dr. S. B. Boadi-Kusi), Medical Laboratory Technology (Dr. K. Ephraim-Dadzie) and Microbiology (Dr. S. Obiri-Yeboah). Patients suffering from HIV/AIDS are susceptible to a variety of complications where the eye is subjected to a wide spectrum of manifestations. Blindness and visual impairment are the ultimate consequences of HIV related ocular complications. The purpose of this project was to evaluate the ocular disorders in HIV positive patients attending the Cape Coast Teaching Hospital, Ghana. Investigations included laboratory examinations, medical profiles and ophthalmic examination. The overall prevalence of ocular disorders was 5.8%, the most common HIV related ocular disorder being HIV retinal microvasculopathy (58.8%), followed by herpes zoster ophthalmicus (HZO) and Toxoplasma retinochoroiditis. Cytomegalovirus (CMV) retinitis, Bell's palsy and optic neuritis were rare cases. Lower CD4 counts and high viral load copies were the associated factors for the manifestation of HIV related ocular disorders. The study recommended early ophthalmic examination for patients with HIV infection. The project findings have been disseminated through two peer-reviewed publications.

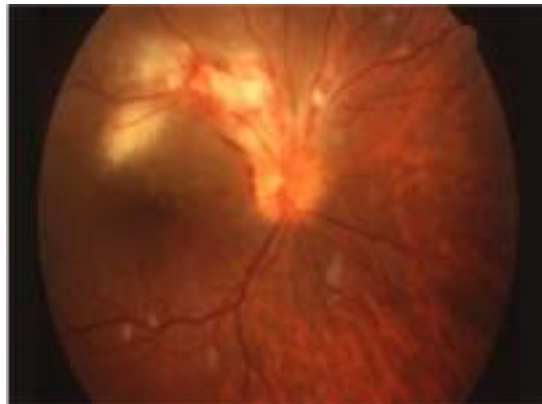

*Fundus photographs showing HIV retinopathy*

## *Occupation Vision, Injury and Visual Hazard Assessment of Mine Workers in Ghana*

Mining contributes significantly to Ghana's gross domestic product (GDP). However the process of mining and mineral treatment exposes those involved in the mining and processing to several visual hazards which can cause injury, induce eye diseases and visual impairment in workers. The economic cost to the individual, the company and the nation in productive time lost is enormous. This project by the Clinical, Occupational, Visual Function Research Group (Dr. Stephen Ocansey, Dr. Emmanuel Abu and Dr. Samuel Kyei) conducted at the Goldfields, Tarkwa and Obuasi Mines was one of the breakthrough projects in any Mine in Ghana. The team gained a real access to undertake risk assessment and also undertake ophthalmic examination on the workers. A summary of major findings was submitted to the Ghana Chamber of Mines and a report presented to the Technical Committee of the Ghana Chamber of Mines at Tarkwa and the Golden Star Resources, Wassa. The project recommended the inclusion of occupation vision requirement assessment for entrance and exit medical screening for the mine workers, which culminated in the establishment of an eye clinic at the Tarkwa ABA Hospital to treat all ambulatory eye conditions, after the team submitted a proposal to the management of the mining companies.



*Inspecting the mines for visual hazards. Here a smog of dust due to the operation of heavy machinery at the Tarkwa mines and poses a threat to the eyes of workers who were found without safety goggles or deliberately refused to wear them because they were purchased without consideration to their visual status.*



*Some identified visual hazards in the mines. Right, the operator of the heavy machinery is required to see the controls of the vehicle, in front of him, other machines and workers nearby which required special lens prescriptions to be worn or incorporated in their safety goggles. Left, tower light used at night had intensity levels that could compromise the integrity of the visual system. (Pictures by Dr. Stephen Ocansey)*

## *Pharmacological effects of Heliotropium Indicum Linn on the Eye*

This project examined the effects of Heliotropium Indicum Linn, a plant found in Ghana that is used as a traditional remedy to assist in eye ailments including cataract, ocular hypertension, intraocular inflammation, and allergic conjunctivitis on the eye. The study, sponsored by University of Cape Coast and the University of KwaZulu Natal, Durban, South Africa, formed part of the PhD thesis of Dr. Samuel Kyei, a member of the Optometry and Vision research Group. It was found that this plant has the capability of reducing inflammation, eye pressure and delaying cataracts in rodents. The project has laid the foundation for further collaborative work between the two universities to be conducted using human subjects. This study is beneficial in addressing avoidable blindness as well as viable affordable treatment options in developing and developed countries.



*Dr. Samuel Kyei, a member of the Optometry and Vision Science group doing toxicology analysis of Heliotropium Indicum Linn plant used as a local herb to treat many eye conditions.*

## *Ocular Health of Cocoa Farmers in Ghana*

This project was a collaboration between the Clinical, Occupational, Visual Function Research Group at the Department of Optometry and the Discipline of Optometry, University of Kwa-Zulu Natal, Durban, South Africa. The study assessed the visual status of cocoa farmers using standard clinical and optometric procedures to evaluate the work-relatedness of the ocular conditions identified among these workers. The study adopted both cross-sectional and a quasi-experimental study designs. An assessment of the knowledge, perceptions, and beliefs of these workers on ocular health and safety practices were critically examined. Based on the

assessment, a training intervention programme was developed and tested among the farmers. The study contributes to a holistic understanding of the work-relatedness of the ocular conditions among cocoa farmers. Furthermore, it demonstrates the possibility of impacting positively on the lives of the cocoa farmers through training programmes and policy initiatives.



*Dr. Samuel Bert Boadi-Kusi of the Clinical, Occupational, Visual Function Research Group inspecting work on a cocoa farm (left) and (right) undertaking internal eye examination of participant using a hand-help slit lamp procured purposely for the project.*

## *Using Electrophysiology to Assess Retinal Function in Autosomal Dominant Optic Atrophy*

Many eye diseases lead to a change in the way in which the eye functions. This may result in obvious symptoms like, a reduced ability to read down the letter chart in a sight test, but sometimes the changes in function are more subtle, and require other types of eye tests for them to be detected. One such clinical test which may be used to assess subtle changes of function in the eyes is electrophysiology. Electrophysiology measures the tiny electrical signals produced by the light-sensitive cells in the retina at the back of the eye when humans look at flashing lights and patterns.



The size and timing of these electrical signals provide an objective measure of retinal function. This project aimed to enhance and develop the recording of electrophysiology in people who have healthy eyes, and to collect recordings from people with a type of inherited optic nerve disease known as autosomal dominant optic atrophy. This project is beneficial in the development of sensitive tests which are able to detect, monitor the rate of progression and/or recovery of insidious ocular diseases glaucoma, retinitis pigmentosa, macula degeneration among others. Part of the findings of the project have been presented at the Young Vision Researchers Colloquium of the Bristol Vision Institute; Jun 24, 2013 at Bristol University, UK and at the 12th Annual British Society for Clinical Electrophysiology of Vision; Sep 9, 2014.

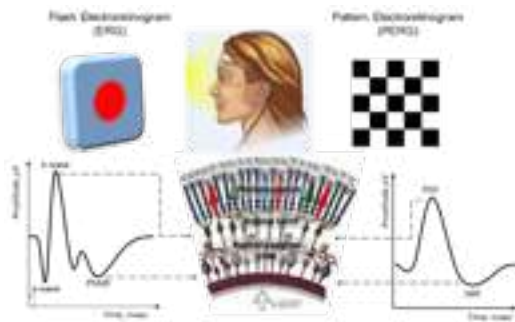

*Study of electrical activity in the retina, ocular electrophysiology. Top row: Electrical activity in the retina can be recorded by connecting special electrodes to the eye and forehead of a participant who is then asked to view a flashing target (left) or a checkerboard pattern (right). Bottom row: The record of the electrical signals, i.e. the electroretinogram (ERG), generated when viewing a flashing target is called the flash ERG; the pattern ERG (PERG) is the record generated when viewing a patterned target. The "peaks" and "troughs" of the ERG and PERG have designated names, e.g. a-wave, b-wave, PhNR (photopic negative response). They are each generated by different cells types (shown by dashed arrows) in the retina, they can be used to assess the function of different cell types in the retina.*

A photograph of three young women with braided hair, smiling and looking at a book together outdoors. The woman on the right is holding the book. They are standing in a grassy area with trees in the background. The title 'COLLEGE OF HUMANITIES AND LEGAL STUDIES' is overlaid on the top left in white text on a dark blue and red background.

# COLLEGE OF HUMANITIES AND LEGAL STUDIES

## Introduction

The College of Humanities and Legal Studies (CHLS) comprises the Faculty of Arts, Faculty of Social Sciences, Faculty of Law and School of Business. The College has been in existence for over 50 years. Starting as a Department in 1962 with the transfer of students and staff of the Department of Liberal and Social Studies from Kwame Nkrumah University of Science and Technology in Kumasi, it was soon transformed into a Faculty with seven departments, namely; English, Classics, Economics, French, Geography, History and Sociology. It was again subdivided into schools: School of Languages and Literature with three departments (Classics, English and French) and School of Social Sciences comprising History, Geography, Sociology and Economics. These two schools were later upgraded to Faculties and have since functioned as such.



**Professor Dora Edu-Buandoh,**

Provost of the College of Humanities and Legal Studies

The School of Business, on its part, was carved out of the Faculty of Social Sciences in 2003 with two main departments, namely; Accounting and Finance and Management Studies. The School has, in its short history, introduced sandwich and regular Bachelors and Masters Programmes and is also collaborating with the College of Distance Education (then Centre for Continuing Education [CCE]) to offer courses through the distance mode. The Faculty of Law is a recent creation of the Academic Board, and has for some time now worked tirelessly to ready itself for the task by recruiting both academic and administrative staff. It began full operations in the 2013/2014 academic year with 62 students. It is clear that the Faculties of Arts and Social Sciences and the School of Business already have a history of integration and collaboration. The inclusion of the Faculty of Law for them to constitute a College further enhances the capacity of these Faculties and School to actualise their collective and individual vision and missions.

These Faculties and School have in various forms implemented their mandates diligently through departments/institutes/centres/units over the years. Indeed, the entire University has promoted academic excellence through this system for some time now. While recognising the gains the system has brought to the University, it is also imperative that the rate at which Faculties/Schools are expanding requires some new social engineering to ensure that teaching and learning progress without necessarily overstretching available human and financial resources. This is a fundamental motivation for establishment of the College of Humanities and Legal Studies.

*Objectives of the College*

The objectives of the College are to:

- Facilitate the promotion of academic work and good governance across faculties/schools
- Promote interdisciplinary activities including research and outreach
- Promote networking and group research based on the University's Research Agenda
- Pool resources to ensure maximum utilisation for research, teaching and outreach.



## SUMMARY OF FUNDED RESEARCH AND CREATIVE PROJECTS

No.	Grant Type	Title of Project	Principal Investigator(s)/ Stakeholders	Department(s)	Source of Funding	Total Amount	Status of Project
<b>FACULTY OF ARTS</b>							
1	Collaborative Research Project	The Formation and Transformation of Musical Archives in West African Societies	Prof. Raimund Vogels ( <i>University of Hildesheim, Germany</i> ) Prof. Bala Dauda ( <i>University of Maiduguri, Nigeria</i> ) Prof. Isaac R. Amuah; and Dr. Florian Carl ( <i>UCC, Ghana</i> )	Centre for World Music, University of Hildesheim, Germany Department of Creative Arts, University of Maiduguri, Nigeria Department of Music & Dance, UCC, Ghana	Volkswagen Foundation	EUR586,000.00	Completed (2009-2015)
2	Interdisciplinary Postgraduate Training Network	Performing Sustainability. Cultures and Development in West Africa	Prof. Raimund Vogels ( <i>University of Hildesheim, Germany</i> ) Dr. Florian Carl ( <i>UCC, Ghana</i> ) Dr. Abba I. Tijani ( <i>University of Maiduguri, Nigeria</i> )	Centre for World Music, University of Hildesheim, Germany Department of Music and Dance, UCC, Ghana Department of Creative Arts, University of Maiduguri, Nigeria	DAAD	EUR 1,912,000.00	Implementation phase (2016-2021)
3	Postdoctoral Fellowship	Seashore Harmonies: Songs of a Dying Fishing Culture	Dr. Eric D. Otchere ( <i>UCC, Ghana</i> )	Department of Music and Dance, UCC, Ghana Department of Music and Musicology, Rhodes University, South Africa	American Council of Learned Societies (ACLS) Postdoctoral Fellowship (2015-2016) Rhodes University Postdoctoral Award (2016-	USD18,000.00 (ACLS African Humanities Programme) R160,000.00 (Rhodes University Postdoctoral Award)	On-going (2015-2017)

## SUMMARY OF FUNDED RESEARCH AND CREATIVE PROJECTS

No.	Grant Type	Title of Project	Principal Investigator(s)/ Stakeholders	Department(s)	Source of Funding	Total Amount	Status of Project
<b>FACULTY OF ARTS</b>							
4	Conference	2nd Triennial Ghana Studies Association (GSA) Conference "Global Ghana"	Dr. Florian Carl ( <i>UCC, Ghana</i> ) Prof. Benjamin Talton ( <i>Temple University, USA</i> ) Dr. Nana Akua Anyidoho ( <i>UG, Ghana</i> )	Department of Music and Dance, UCC, Ghana Centre for the Study of Force and Diplomacy (CENFAD), Temple University, USA Institute of Statistical, Social, and Economic Research (ISSER), UG, Ghana	ISSER, University of Ghana African and African American Studies Programme, Dartmouth College, USA Institute of African Studies, Columbia University, USA CENFAD, Temple University, USA Association for the Study of the Worldwide African Diaspora (ASWAD)	GHC31,040000	Completed (2016)
5	Performance Production	"Black Water" - A Collaborative Theatre and Dance Production	Frank Heuel ( <i>Fringe Ensemble Bonn, Germany</i> ) Dr. Florian Carl; and Dr. Vitus Nambigne ( <i>UCC, Ghana</i> )	Fringe Ensemble Bonn, Germany Department of Music & Dance, UCC, Ghana Department of Theatre & Film Studies, UCC, Ghana	City of Bonn, Germany European Union Ministry of Family, Children, Youth, Culture and Sports, NRW, Germany Goethe Institute, Accra	EUR7,500000	Completed (2016)
6	Performance Production	Nkrumah's Vision of One Africa: The Reality	Margaret D. Numekavor ( <i>UCC, Ghana</i> )	Department of Music & Dance, UCC	Embassy of the United States of America, Ghana	GHC9,720000	Completed (2013)

## SUMMARY OF FUNDED RESEARCH AND CREATIVE PROJECTS

No.	Grant Type	Title of Project	Principal Investigator(s)/ Stakeholders	Department(s)	Source of Funding	Total Amount	Status of Project
<b>FACULTY OF ARTS</b>							
7	Video Production	Educational Video on Diabetes Mellitus	Dr. Vitus Nanbigne ( <i>UCC, Ghana</i> )	Department of Theatre and Film Studies, UCC	School of Medical Sciences, UCC	GHC8,580,000	Completed (2015)
8	Performance Production	Black History Month	Eiolo Gharbin (UCC, Ghana)	Department of Theatre and Film Studies, UCC	Embassy of the United States of America, Ghana	GHC31,690,000	Completed (2015)
9	Theatre for Development Project	UNICEF Theatre for Development Project	Eiolo Gharbin (UCC, Ghana)	Department of Theatre and Film Studies, UCC Ghana Health Service, Cape Coast	UNICEF	GHC29,000,000	Completed (2012)
10	Book Project	Harnessing Cultural Capital for Sustainability	Prof. Samuel Awuah-Nyamekye ( <i>UCC, Ghana</i> ) Munyaradzi Mawere ( <i>Great Zimbabwe University</i> )	Department of Religion and Human Values, UCC Faculty of Culture and Heritage Studies, Great Zimbabwe University	Langaa Research and Publishing Common Initiative Group, Mankon-Bamenda, Cameroon	USD3,000,000	Completed (2015)
11	Book Project	Managing the Environmental Crisis in Ghana: The Role of African Traditional Religion and Culture with Special Reference to Berekum Traditional Area	Prof. Samuel Awuah-Nyamekye ( <i>UCC, Ghana</i> )	Department of Religion & Human Values, UCC, Ghana	Cambridge Scholars Publishing Ltd., UK	GBP3,000,000	Completed (2014)



## SUMMARY OF FUNDED RESEARCH AND CREATIVE PROJECTS

No.	Grant Type	Title of Project	Principal Investigator(s)/ Stakeholders	Department(s)	Source of Funding	Total Amount	Status of Project
<b>FACULTY OF ARTS</b>							
12	Book Project	The Hebrew Bible and the Five Books of Moses	Augustine M. Mensah (UCC, Ghana)	Department of Religion & Human Values, UCC, Ghana	Self-funded	GHC5,000.00	Completed (2016)
13	Collaborative Research Project	Ghana Values Studies: Towards the Realisation of Ghanaian Human Values for Governance and Global Citizenship	Simon K. Appiah (UCC, Ghana) Sigrid Müller (University of Vienna, Austria)	Department of Religion & Human Values, UCC, Ghana Faculty of Theology, University of Vienna, Austria	University of Vienna, Austria	USD1,094,25	On-going
14	Book Project	Between Rhetoric and Reality: The State and Use of Indigenous Knowledge in Post-Colonial Africa	Samuel Awuah-Nyamekye (UCC, Ghana) Munyaradzi Mawere (Great Zimbabwe University)	Department of Religion & Human Values, UCC, Ghana Faculty of Culture and Heritage Studies, Great Zimbabwe University	Langa Research and Publishing Common Initiative Group, Mankon-Bamenda, Cameroon	USD 3,000,000	Completed (2015)
15	Book Project	A History of the University of Cape Coast: Fifty Years of Excellence in Tertiary Education, 1962-2012	Prof. Kwame O. Kwarteng; D. A. Dwariko; and Dr. S. Y. Boadi-Slaw (UCC, Ghana)	Department of History, UCC, Ghana	UCC, Ghana	GHC5,000.00	Completed (2012)
16	Book Project	A History of CHASS: Fifty Years of Providing Quality Leadership in Secondary Education in Ghana, 1962-2012	Prof. Kwame O. Kwarteng Dr. S. Y. Boadi-Slaw Augustine Osei Duah Stephen Osei Owusu (UCC, Ghana)	Department of History, UCC, Ghana	CHASS, Ghana	GHC5,000,000	Completed (2012)

## SUMMARY OF FUNDED RESEARCH AND CREATIVE PROJECTS

No.	Grant Type	Title of Project	Principal Investigator(s)/ Stakeholders	Department(s)	Source of Funding	Total Amount	Status of Project
<b>FACULTY OF ARTS</b>							
17	Book Project	Africa and the First World War: Remembrance, Memories and Representations after Hundred Years	Prof. Kwame O. Kwarteng; Kwabena A. Parry; Prof. De-Valera N. Y. Botchway (UCC, Ghana)	Department of History, UCC	Ghana Armed Forces Cambridge Publishers, UK	GHC30,000,000	Completed (2016)
<b>FACULTY OF ARTS</b>							
18	Collaborative Research Project	Attitudes of Judges and Lawyers on the Application of International Law in Domestic Cases	Julia E. Selman-Ayetey, AKC; and Dr. Bolanle Erinoso (UCC, Ghana)	Faculty of Law, UCC, Ghana	Researchers	-----	2016-Date
19	Academic Advancement	"Human Rights & The Prison System" to Prison Officers at Ankaful Maximum Security Prison	Julia E. Selman-Ayetey, AKC (UCC, Ghana)	Faculty of Law, UCC, Ghana	Researcher	-----	Completed (2014)
20	-----	The Ghanaian Council of State: Free & Fit to Counsel	Julia E. Selman-Ayetey, AKC (UCC, Ghana)	Faculty of Law, UCC, Ghana	-----	-----	Completed (Dec. 2015- June 2016)
21	-----	Recognition of States and Governments	Julia E. Selman-Ayetey, AKC (UCC, Ghana)	Faculty of Law, UCC, Ghana	-----	-----	Completed (April 2015- Dec. 2015)

## SUMMARY OF FUNDED RESEARCH AND CREATIVE PROJECTS

No.	Grant Type	Title of Project	Principal Investigator(s)/ Stakeholders	Department(s)	Source of Funding	Total Amount	Status of Project
<b>FACULTY OF LAW</b>							
22	Individual Research Project	The African Convention on the Conservation of Nature and Natural Resources, Prospects for a Comprehensive Treaty for the Management of Africa's Natural Resources	Dr. Bolanle Erinoshio (UCC, Ghana)	Faculty of Law, UCC, Ghana	Researcher		
23	Individual Research Project	Water Resources: The Need for a Comprehensive Treaty for the Management of Shared Water Resources in Africa	Dr. Bolanle Erinoshio (UCC, Ghana)	Faculty of Law, UCC, Ghana	Researcher		
24	Individual Research Project	Intellectual Property Rights for Plant Genetic Resources: Ghana's Plant Breeders' Bill 2013	Dr. Bolanle Erinoshio (UCC, Ghana)	Faculty of Law, UCC, Ghana	Researcher		
25	Individual Research Project	Environmental Law in Africa Ibadan: Kraft Publishers December 2015	Dr. Bolanle Erinoshio (UCC, Ghana)	Faculty of Law, UCC, Ghana	Researcher		



## SUMMARY OF FUNDED RESEARCH AND CREATIVE PROJECTS

No.	Grant Type	Title of Project	Principal Investigator(s)/ Stakeholders	Department(s)	Source of Funding	Total Amount	Status of Project
<b>FACULTY OF LAW</b>							
26	Departmental Research Project	The Ethnic Factor in the Political, Social and Economic Life of the People of Asuogyaman District	Mr. Richard Ametefe (UCC, Ghana)	Faculty of Law, UCC, Ghana	Researcher		Completed (2009-2012)
27	Collaborative Research Project	The Ethnic Factor in the Political Life of the People of Asuogyaman District	Dr. Kenneth S. Aikins; and Mr. Richard Ametefe (UCC, Ghana)	Institute for Development Studies (IDS), UCC, Ghana Faculty of Law, UCC, Ghana	Researcher		2014-2016 (Submitted to SAGE for publication)
28	Collaborative Research Project	Labour Disputes and Compliance with the Labour Laws in Ghana	Mr. Imoro R. Jaha; Mr. Richard Ametefe; and Mr. Felix Apraku Awuah (UCC, Ghana)	Department of Sociology & Anthropology, UCC, Ghana Faculty of Law, UCC, Ghana	Researchers		2015-Date
29	Individual Research Project	Human Right Abuses of Mental Patients in Ghana	Mr. Richard Ametefe (UCC, Ghana)	Faculty of Law, UCC, Ghana	Researchers		2016-Date

## SUMMARY OF FUNDED RESEARCH AND CREATIVE PROJECTS

No.	Grant Type	Title of Project	Principal Investigator(s)/ Stakeholders	Department(s)	Source of Funding	Total Amount	Status of Project
<b>FACULTY OF SOCIAL SCIENCES</b>							
30	Collaborative Research Project	Trust, Risk and Uncertainty in Medicinal Transactions in Sub-Saharan Africa: Integrating Behavioural Game Theory and Ethnography to Develop a Robust Analytical Framework to Address a Major Global Public Health Challenge	Dr. Kate Hampshire ( <i>Durham University, UK</i> ) Dr. Heather Hamill ( <i>Oxford University, UK</i> ) Dr. Simon Mariwah; and Mr. Daniel Amoako-Sakyi ( <i>UCC, Ghana</i> ) Dr. Joseph Nwamga ( <i>NIMR, Tanzania</i> ) Mrs. Abigail Kyel ( <i>Pentecost University, Ghana</i> )	Durham University, UK Department of Geography & Regional Planning, UCC, Ghana Anthropology (Durham)	The Wellcome Trust	GBP49,954,000	On-going (2016-2017)
31	Collaborative Research Project	Establishment of an International Research partnership between University of Cape Coast, Ghana and University of Bradford, UK in the field of Human Resource Development for Public Sector Reform	Prof. Farhad Analoui ( <i>University of Bradford, UK</i> ) Prof. Kwabena B. Antwi; and Dr. Simon Mariwah ( <i>UCC, Ghana</i> ) Department of Geography & Regional Planning, UCC, Ghana Bradford Centre for International Development, UK	Department of Geography & Regional Planning, UCC, Ghana Bradford Centre for International Development, UK	The British Academy	GBP28,820,000	On-going (2015-2017)
32	Collaborative Research Project	Mobile Phones and Youth in Sub-Saharan Africa	Dr. Gina Porter; and Dr. Kate Hampshire ( <i>Durham University, UK</i> ) Prof. Albert M. Abane ( <i>UCC, Ghana</i> )	Anthropology, Durham Department of Geography & Regional Planning, UCC, Ghana	Economic and Social research Council (ESRC) DFID, UK	GBP460,000,000	Completed (2009-2012)

## SUMMARY OF FUNDED RESEARCH AND CREATIVE PROJECTS

No.	Grant Type	Title of Project	Principal Investigator(s)/ Stakeholders	Department(s)	Source of Funding	Total Amount	Status of Project
<b>FACULTY OF SOCIAL SCIENCES</b>							
33	Collaborative Research Project	What has Poverty Got to do with it? Asset-based Approach Household Access to Improved Sanitation in Ghana	What has Poverty Got to do with it? Asset-based Approach Household Access to Improved Sanitation in Ghana Dr. Simon Mariwah; Dr. Joshua Amo-Adjei; and Ms. Prisca A. Anima (UCC, Ghana)	Department of Geography & Regional Planning, UCC, Ghana Department of Population & Health, UCC, Ghana	DRIC, UCC, Ghana	GHC20,000,000	Completed (2015)
34	Collaborative Research Project	Cashew Cultivation, Access to Land and Food Security in Brong-Ahafo Region, Ghana: Preventing the Intergenerational Transmission of Poverty	Prof. Ruth Evans (University of Reading, UK) Dr. Simon Mariwah; and Prof. Kwabena B. Antwi (UCC, Ghana)	Department of Geography & Regional Planning, UCC, Ghana; Department of Geography & Environmental Science, University of Reading	Walker Institute for Climate System Research, University of Reading	GBP7,323,000	Completed (2012-2014)
35	Consultancy Project	Design and Implementation of a Cross-Sectional Impact Assessment of the Business Environment Strengthening for Ghana Business Advocacy Component	Prof. Albert M. Abane; Prof. Samuel K. Annim; and Prof. E. Marfo-Yiadom (UCC, Ghana)	Department of Geography & Regional Planning, UCC, Ghana Department of Economics, UCC, Ghana School of Business, UCC, Ghana	DANIDA Ghana, Accra	USD53,740,000	Completed (2013-2014)
36	Consultancy Project	Assessment of Poverty Outreach & Impact of Rural and Micro Finance Institutions and Government Credit Programmes in Ghana under RAFiP	Prof. Samuel K. Annim; Prof. Kofi Awusabo-Asare; and Prof. Albert M. Abane (UCC, Ghana)	Department of Economics, UCC, Ghana Department of Population & Health, UCC, Ghana Department of Geography & Regional Planning, UCC, Ghana	Rural and Agricultural Finance Programme (RAFiP), Ministry of Finance and Economic Planning	GHC569,880,000	Completed (2016)



## SUMMARY OF FUNDED RESEARCH AND CREATIVE PROJECTS

### FACULTY OF SOCIAL SCIENCES

No.	Grant Type	Title of Project	Principal Investigator(s)/ Stakeholders	Department(s)	Source of Funding	Total Amount	Status of Project
37	Collaborative Research Project	Experimental Enhanced Financial Literacy Training for Women Groups and Farmer Based Organisations under RAFiP	Dr. James Attah Peprah, Dr. Camara K. Obengi, and Dr. Martin Bosompem (UCC, Ghana)	Department of Economics, UCC, Ghana Department of Agricultural Economics & Extension, UCC, Ghana	RAFiP Ministry of Finance and Economic Planning	GH¢611,650.00	Completed (2015)
38	Collaborative Research Project	A Transnational Study of the Relevance of LMD/BMD Reforms to the Socio-economic Development of West and Central African Countries: Case Study of Ghana, Sierra Leone, Cameroon and WAEMU Countries	Prof. Damian K. Mereku (University of Education, Winneba, Ghana) Dr. William Boateng (UCC, Ghana) Mr. Joshua Baku (ERNWACA, Ghana)	University of Education, Winneba, Ghana Department of Sociology & Anthropology UCC, Ghana ERNWACA, Ghana	Educational Research Network for West and Central Africa (ERNWACA)	USD20,000.00	Completed (2016)

## SUMMARY OF FUNDED RESEARCH AND CREATIVE PROJECTS

No.	Grant Type	Title of Project	Principal Investigator(s)/ Stakeholders	Department(s)	Source of Funding	Total Amount	Status of Project
<b>FACULTY OF SOCIAL SCIENCES</b>							
39	Collaborative Research Project	The Impact of Gender and Sexual Identity Acquisition on Children and Young People's Views and Understandings of Gender-Based Violence, Power and Oppression in Ghana  An International Research Partnership between Cape Coast University, Ghana and the University of Sheffield, UK, in the area of International Partnership and Mobility Scheme Programme	Dr. Afua Twum-Danso Imoh ( <i>University of Sheffield, UK</i> ); Prof. Mansah Prah; Dr. (Mrs.) Georgina Y. Oduro; and Ms. Dorothy Takyiakwa ( <i>UCC, Ghana</i> )	Department of Sociology & Anthropology, UCC, Ghana	The British Academy	GBP30,000,000	On-going
40	Collaborative Research Project	Comparative Study of Police Training Practices in the US and Ghana	Prof. Samuel Abaidoo; and Dr. Heidi Scherer ( <i>Kennesaw State University, USA</i> ); Dr. William Boateng ( <i>UCC, Ghana</i> )	Kennesaw State University, USA Department of Sociology & Anthropology, UCC, Ghana	Strategic Internationalisation Grants Initiatives (Kennesaw State University, USA)	USD10,000,000	On-going

## SUMMARY OF FUNDED RESEARCH AND CREATIVE PROJECTS

No.	Grant Type	Title of Project	Principal Investigator(s)/ Stakeholders	Department(s)	Source of Funding	Total Amount	Status of Project
<b>FACULTY OF SOCIAL SCIENCES</b>							
41	Collaborative Research Project	Investigating Technology-mediated Faculty-Student Interactions among Graduate Ghanaian University Students	Dr. Raymond Tutu ( <i>Daleware State University, USA</i> ) Dr. John Boateng ( <i>UG, Ghana</i> ) Dr. William Boateng ( <i>UCC, Ghana</i> )	Department of Sociology & Anthropology, UCC, Ghana	Council for the Development of Social Science Research in Africa (CODESRIA)	USD25,00000	On-going (2015-2017)
42	Collaborative Research Project	Gender Equality and Women's Rights in Rural Livelihoods: Evidence from Selected Asian and African Countries - 2016	Prof. Akua O. Britwum; and Dr. Angela D. Akorsu ( <i>UCC, Ghana</i> ) Prof. Saira Ankar; and Dr. Abdul Ghafoor ( <i>Pakistan</i> ) Dr. Susan W. Njogu ( <i>Kenya</i> ) Prof. Varsha Ayyar ( <i>India</i> )	CEGRAD, UCC, Ghana	International Centre for Development and Decent Work (ICDD)	GH¢10,253,000	On-going (Data Analysis)
43	Collaborative Research Project	Gender Orders and Higher Education in the University of Cape Coast College of Distance Education - 2016	Prof. Akua O. Britwum ( <i>UCC, Ghana</i> )	CEGRAD, UCC, Ghana	College of Distance Education (CODE) UCC, Ghana	Unspecified	On-going (Data Analysis)
44	Collaborative Research Project	Rural-Urban Linkages: Precarious Urban Work and precarious Rural Livelihoods Connections in South Africa and Ghana - 2016	Prof. Akua O. Britwum ( <i>UCC, Ghana</i> ) Dr. Ben Scully ( <i>University of Witwatersrand, South Africa</i> )	CEGRAD, UCC, Ghana	International Centre for Development and Decent work (ICDD)	GH¢24,280,000	On-going (Data analysis after joint data collection in South Africa and Ghana)

## SUMMARY OF FUNDED RESEARCH AND CREATIVE PROJECTS

No.	Grant Type	Title of Project	Principal Investigator(s)/ Stakeholders	Department(s)	Source of Funding	Total Amount	Status of Project
<b>FACULTY OF SOCIAL SCIENCES</b>							
45	Collaborative Research Project	Men, Gender Equality, and Parental Leave Systems - 2015	Prof. Akua O. Britwum (UCC, Ghana) Prof. José Andrés Fernández Cornejo (Spain)	CEGRAD, UCC, Ghana	Universidad Complutense de Madrid, Spain,	GHC3,878.00	On-going (Data Analysis)
46	Collaborative Research Project	Gender Equality and Women's Rights in Rural Livelihoods in Ghana and Pakistan - 2015	Prof. Akua O. Britwum; and Dr. Angela D. Akorsu; Prof. Augustine Tanle (UCC, Ghana)  Prof. Saira Ahktar (University of Agriculture, Faisalabad, Pakistan); and Dr. Abdul Ghafoor (Pakistan)	CEGRAD, UCC, Ghana  Department of Population & Health, UCC, Ghana	ICDD	GHC12, 631.00	Completed
47	Collaborative Research Project	Organising Non Standard Workers in Ghana, South Africa and India: Domestic Workers - 2014	Dr. Angela D. Akorsu; and Ms. Amanda Odoi (UCC, Ghana) Prof. Emeritus E. Webster (University of Witwatersrand, South Africa) Late Prof. Sharit Bhowmik (India)	CEGRAD, UCC, Ghana	ICDD	GHC7,000.00	Completed
48	Collaborative Research Project	Organising Non Standard Workers in Ghana, South Africa and India: Oil Palm Plantation Workers - 2014	Prof. Akua O. Britwum and Dr. Angela D. Akorsu (UCC, Ghana) Prof. Emeritus Edward Webster (South Africa) Late Prof. Sharit Bhowmik (India)	CEGRAD, UCC, Ghana	ICDD	GHC10,500.00	Completed



## SUMMARY OF FUNDED RESEARCH AND CREATIVE PROJECTS

### FACULTY OF SOCIAL SCIENCES

No.	Grant Type	Title of Project	Principal Investigator(s)/ Stakeholders	Department(s)	Source of Funding	Total Amount	Status of Project
49	Research-based Consultancy	Evaluation of Gender Aspects of Agricultural Intensification Practices in Northern Ghana	Prof. Akua O. Britwum; and Dr. Angela Akorsu (UCC, Ghana)	CEGRAD, UCC, Ghana Institute for Development Studies (IDS), UCC, Ghana	Africa Research in Sustainable Intensification for the Next Generation (Africa RISING) of the International Institute of Tropical Agriculture (IITA)	GHC900000.00	Completed
50	Collaborative Research Project	Design of Manual on Mediation Strategies for the Capacity Building of Staff of the National Peace Council	Prof. Stephen B. Kendie; Dr. Patrick Osei-Kufuor; and Dr. Kenneth S. Aikins (UCC, Ghana)	IDS, UCC, Ghana	United Nations Development Programme (UNDP)  USAID	GHC400000.00	Manual titled: Doing Mediation - A Guide for Practitioners (completed and first set of training has been conducted 2016)
51	Collaborative Research Project	Design of Manual for Capacity Building of Traditional Authorities and Religious Leaders in Conflict Management and Peace Building (2015)	Prof. Stephen B. Kendie; Dr. Patrick Osei-Kufuor; and Dr. Kenneth S. Aikins; Prof. Kwaku A. Boakye; (UCC, Ghana)	IDS, UCC, Ghana Department of Hospitality & Tourism Management, UCC, Ghana	UNDP	GHC600000.00	Manual titled: Strengthening the capacity of traditional authorities and religious leaders in conflict management, and peace building has been completed. Training yet to start

## SUMMARY OF FUNDED RESEARCH AND CREATIVE PROJECTS

No.	Grant Type	Title of Project	Principal Investigator(s)/ Stakeholders	Department(s)	Source of Funding	Total Amount	Status of Project
<b>FACULTY OF SOCIAL SCIENCES</b>							
52	Collaborative Research Project	Mapping Violent Conflicts in Ghana	Prof. Stephen B. Kendie; Dr. Patrick Osei-Kuffor; and Dr. K. Addo Tuffour; Prof. Kwaku A. Boakye; and Mr. Emmanuel A. Mensah (UCC, Ghana)	IDS, UCC, Ghana Department of Hospitality & Tourism Management, UCC, Ghana Department of Geography & Regional Planning (UCC)	UNDP IDS, UCC	GHC120,000,000 GHC30,000,000	2012 - 2014 Book with the same title published and the online map is available at <a href="http://www.mint.govhttp://www.mint.gov">www.mint.gov</a>
53	Collaborative Research	Review of Inter-party Dialogue Mechanisms in 10 West African Countries	Prof. Stephen B. Kendie; and Dr. K. Addo Tuffour (UCC, Ghana)	IDS, UCC, Ghana	Institute for Democracy and Electoral Assistance (IDEA)	EUR7,000,000	(August-October 2011) Research completed and submitted to IDEA
54	Collaborative Research	Exploring the Role of CSOs in Conflict Prevention and Management in Northern Ghana	Prof. Stephen B. Kendie; Dr. Patrick Osei-Kuffor; and Prof. Kwaku A. Boakye (UCC, Ghana)	IDS, UCC, GhanaA IDS, UCC, Ghana Department of Hospitality & Tourism Management, UCC, Ghana	DRIC, UCC	GHC20,000,000	Research completed and report submitted to DRIC
55	Collaborative Research Project 2016	Mapping of Support Organisations in Girls' Education	Prof. Patrick K. Agbesinyale; Dr. Kenneth S. Aikins; and Ms. J. Awuni (UCC, Ghana)	IDS, UCC, Ghana	UNICEF/ Ghana Education Service	GHC36,320,000	Completed (Directory in print)

## SUMMARY OF FUNDED RESEARCH AND CREATIVE PROJECTS

No.	Grant Type	Title of Project	Principal Investigator(s)/ Stakeholders	Department(s)	Source of Funding	Total Amount	Status of Project
<b>FACULTY OF SOCIAL SCIENCES</b>							
56	Collaborative Research Project 2015	Assessing the Effectiveness and Capacity Building Needs of the National Service Personnel and National Service Secretariat for their Full Integration and Scale-up in the Complementary Basic Education Programme	Prof. Patrick K. Agbesinyale; Dr. Kenneth S. Aikins; Prof. Francis Enu-Kwesi; Dr. Joseph B. Agyenim; Dr. Emmanuel Y. Tenkorang; and Dr. Frederick Koomson ( <i>UCC, Ghana</i> )	IDS, UCC, Ghana	UNICEF	GH¢302,992.00	Completed
57	Collaborative Research Project 2013	Socio-Economic Baseline Study of the Fosu Lagoon in the Cape Coast Metropolis in Ghana	Prof. John V. Mensah; Prof. Francis Enu-Kwesi; Dr. Angela D. Akorsu; and Dr. Owusu Boampong ( <i>UCC, Ghana</i> )	Institute for Development Studies (IDS-UCC);	Cape Coast Metropolitan Assembly	GH¢30,000,000	Completed
58	Collaborative Research Project	Environmental, Social and Health Baseline Study of Six Coastal Districts in the Western Region Fringing Ghana's Oil Field	Prof. Patrick K. Agbesinyale; Prof. John V. Mensah; and Prof. Joseph Aggrey-Fynn ( <i>UCC, Ghana</i> )	IDS, UCC, Ghana Department of Fisheries & Aquatic Science, UCC, Ghana	Eni-Ghana	USD56,000,000	Completed

## SUMMARY OF FUNDED RESEARCH AND CREATIVE PROJECTS

No.	Grant Type	Title of Project	Principal Investigator(s)/ Stakeholders	Department(s)	Source of Funding	Total Amount	Status of Project
<b>FACULTY OF SOCIAL SCIENCES</b>							
59	Consultancy Project	Consulting Services to conduct a Mid-Term Population-Based Survey (PBS) in Support of USAID-Ghana's 'Fit' Programme	Prof. Kofi Awusabo-Asare Prof. Samuel K. Annim Dr. David T. Doku Dr. Benjamin K. Nyarko (UCC, Ghana)	Department of Population & Health, UCC, Ghana	USAID	GHC2,061,000	Completed (2015)
60	Postdoctoral Fellowship	Life-course Approach to Health Inequalities	Dr. David T. Doku (UCC, Ghana)	Department of Population & Health, UCC, Ghana	University of Tampere, Finland	Salary based	On-going
61	Collaborative Research Project	Implementation of Sexuality Education Policies and Curricula in Developing Countries: A Multi-country Study	Department of Population & Health, UCC, Ghana	Guttmacher Institute, USA	University of Tampere, Finland		On-going
62	Consultancy	Review of Ghana's Adolescent Reproductive Health Policy	Prof. Kofi Awusabo-Asare; Prof. Akwasi Kumi-Kyereme; Dr. David T. Doku; and Dr. Joshua Amo-Adjei (UCC, Ghana)	Department of Population & Health, UCC, Ghana	National Population Council, Ghana		On-going
63	Consultancy	Development of Implementation Plan for Ghana's Adolescents Reproductive Health Policy	Prof. Kofi Awusabo-Asare; Prof. Akwasi Kumi-Kyereme; Dr. David T. Doku; and Dr. Joshua Amo-Adjei (UCC, Ghana)	Department of Population & Health, UCC, Ghana	National Population Council, Ghana		On-going



## SUMMARY OF FUNDED RESEARCH AND CREATIVE PROJECTS

No.	Grant Type	Title of Project	Principal Investigator(s)/ Stakeholders	Department(s)	Source of Funding	Total Amount	Status of Project
<b>SCHOOL OF BUSINESS</b>							
64	Consultancy	Graduate Enterprise Development Initiative	Prof. Rosemond Boohene; and Dr. Daniel Agyapong; and Dr. Martin Bosompem (UCC, Ghana)	School of Business, UCC, Ghana Department of Agricultural Economics & Extension, UCC, Ghana DRIC, UCC, Ghana	Exim Bank, Accra, Ghana	GHC796,707.75	On-going (2016-2018)
65	Collaborative Research Project	Universities, Entrepreneurship and Enterprise Development in Africa	Prof. Dr. Rosemond Boohene; and Dr. Daniel Agyapong (UCC, Ghana) Prof. Dr. Jurgen Bode (Bonn-Rhein-Sieg University, Germany ) Dr. James Muranga Njihia University of Nairobi, Kenya	School of Business, UCC, Ghana Bonn-Rhein-Sieg University, Germany University of Nairobi, Kenya	German Ministry of Education; and the German Academic Exchange Service	EUR400,000.00	On-going (2015-2018)
66	Collaborative Research Project	Teaching for Development: Entrepreneurship and Sustainable Economic Development in Africa	Prof. Rosemond Boohene; and Dr. Daniel Agyapong (UCC, Ghana)	School of Business, UCC, Ghana Bonn-Rhein-Sieg University, Germany	German Ministry of Education; and the German Academic Exchange Service	EUR200,000.00	Completed (2012-2014)

# DESCRIPTION OF FUNDED RESEARCH AND CREATIVE PROJECTS

## *The Formation and Transformation of Musical Archives in West African Societies*

Designed as an interdisciplinary cooperation between Ghanaian, German and Nigerian scholars working in the fields of musicology and arts education, this research project investigated the formation and transformation of musical archives in West Africa. The research was based on the notion of musical archives in a dual sense. While material archives play a crucial role in the representation and institutionalisation of modern identities, the embodied knowledge of ideal archives forms the basis of musical practice and social memory. The project investigated the history and sociocultural significance of media archives, educational archives, and embodied archives in Ghana and Nigeria in their relation to technology and musical practice. A specific research focus was on the negotiation of contemporary African identities as they are articulated in the emergence of musical genres, styles, and institutions.

The project provided scholarships for twelve postgraduate students from Ghana and Nigeria at the Master's and PhD levels, who met in annual workshops to discuss their individual research projects, developed and worked on joint research questions pertaining to musical practice, social memory and identity. The project was crowned with an international conference, which was held from 10th -13th June, 2015 at Dhow Countries Music Academy, Zanzibar, Tanzania. The initially planned conference at the University of Cape Coast in 2014 had to be relocated because of the Ebola pandemic in parts of West Africa and the temporal ban on international conferences in Ghana during that period. Apart from publications by individual members of the research collaboration, a joint publication edited by the main cooperation partners under the title *Memory, Power and Knowledge in African Music and Beyond* (Olms Verlag, forthcoming) summarise the findings of the research project.



*Cooperation partners from Ghana, Nigeria and Germany and participating postgraduate students meet at the Centre for World Music, University of Hildesheim, Germany*



*Dr. Florian Carl, the Co-ordinator of the Project, Dr. Eric Debrah Otchere, one of the participating postgraduate students, who completed his doctoral degree in 2013, in the Department of Music and Dance at UCC, during a focus group discussion on the reception of gospel music videos (Photo credit: Johannes Kühner).*



*Project participants in a discussion at the Department of Music and Dance, University of Cape Coast. From left to right: Mr. John W. Dankwa, Dr Eric D. Otchere, Dr. Florian Carl (all UCC) and Dr Eva Ebeli (University of Education, Winneba) (photo credit: Johannes Kühn).*



*Dr. Eric D. Otchere, a project participant from UCC, recording children singing games at a primary school in Cape Coast (photo credit: Johannes Kühn).*

## **Interdisciplinary Postgraduate Training Network ('Graduate School') "Performing Sustainability. Cultures and Development in West Africa"**

The DAAD 'Graduate School' Performing Sustainability. Cultures and Development in West Africa is a five-year collaborative training network for postgraduate students from Nigeria, Ghana and Germany. The funding for the 'Graduate School' was approved in October 2016 and the project is currently in its implementation phase. The main collaborating partners and signatories of the proposal include Professor Raimund Vogels, Director of the Centre for World Music and the University of Hildesheim, Germany, Dr. Abba Isa Tijani, Head of the Department of Creative Arts at the University of Maiduguri, Nigeria, and Dr. Florian Carl, Head of the Department of Music and Dance at UCC. At UCC, close cooperation partners also include Dr. Simon Mariwah of the Department of Geography and Regional Planning as well as Dr. Patrick Osei-Kufuour from the Institute for Development Studies.

The project focuses on capacity building and postgraduate training, seeking to support innovative PhD research in the areas of performance studies and sustainable development. To that effect, six three-year PhD scholarships will be available for candidates at UCC beginning in 2017. One particular aim of the 'Graduate School' is to develop applied solutions to the UN Sustainable Development Goals (SDGs), bringing together social science research, cultural studies, and the performing arts. To that effect, all participants will meet twice a year for a three-week workshop at UCC to learn

together and develop research questions and projects. A specific focus is on peace and conflict resolution, which is a particular challenge for the Nigerian partners in Maiduguri, but the project will also include other fields of sustainable development, particularly with regard to building and promoting a socially inclusive, just, and peaceful societies and institutions.



*Dr Florian Carl, Head of the Department of Music and Dance and main cooperation partner at UCC for the DAAD-funded 'Graduate School' Performing Sustainability. Cultures and Development in West Africa*



## **Dr Eric D. Otchere's Postdoctoral Research Project "Seashore Harmonies: Songs of a Dying Fishing Culture"**

Indigenous Ghanaian fishermen who populate Ghana's southern border on the Coast of the Gulf of Guinea propelled their canoes and boats through manual rowers and sang as they rowed the sea. These songs, which served a variety of useful purposes, have grown functionally redundant since outboard motors have come as a convenient substitute to the manual rowing. The time for singing now is when the fishermen are hauling their nets ashore. Their songs, apart from providing useful reference points for synchronising their individual efforts and hence easing the labour, also contain vital pieces of encoded information. Unfortunately, modernism has made the death of this fishing culture imminent, as equipment for pulling fishing nets have already been embraced in many places. In his postdoctoral research project "Seashore Harmonies: Songs of a Dying Fishing Culture" Dr. Otchere investigates some of the surviving singing-fishing communities in Cape Coast. His project documents the songs and examines the extent to which they reflect the belief system, identity, cosmology, genealogy and general philosophy of life of the people. Apart from helping to preserve these songs, the project also explores various lessons that can be learned from this singing tradition to improve music education practice in Ghana.



*Dr. Eric Debrah Otchere of the Department of Music and Dance, UCC (Photo credit: Florian Carl)*



*A cross-section of fishermen singing as they haul their seines ashore (Photo credit: Eric D. Otchere)*



*A cross-section of fishermen singing as they haul their seines ashore (Photo credit: Eric D. Otchere)*

## **The 2nd Triennial Ghana Studies Association (GSA) Conference "Global Ghana", held 6-9 July 2016 at UCC**

The Department of Music and Dance hosted the 2nd Triennial Conference of the Ghana Studies Association (GSA) on the theme, "Global Ghana", which took place on the campus of UCC from 6th -9th July 2016. The interdisciplinary gathering brought together about 100 African, European and North American scholars from various disciplines in the humanities and social sciences. Participants presented and discussed a variety of issues pertaining to Ghana in the globalised age. Sub-themes included areas such as migration, tourism, politics and commerce, media, technology, as well as music, arts and popular culture. The conveners of the conference were Benjamin Talton (Temple University, USA), Florian Carl (UCC) and Nana Akua Anyidoho (UG, Legon). The Local Arrangements Committee included Florian Carl and Eric Debrah Otchere of the Department of Music and Dance, UCC.

The keynote address, entitled "Genealogies of Cosmopolitanism: Accra's Oxford Street", was delivered by Ato Quayson, Professor of English and Director of the Centre for Diaspora and Transnational Studies at the University of Toronto, Canada. Among others, the programme also included a panel on "Praxis, Perspectives and Methods on Ghanaian Popular Music: A Panel in Honour of John Collins" which featured presentations from Florian Carl (UCC), Eric Debrah Otchere (UCC), Nate Plageman (Wake Forest University, USA) and Jesse Weaver Shipley (Dartmouth College, USA). The publication of selected papers from the conference is planned as a Special Issue of GSA's peer-reviewed journal Ghana Studies.



The conference was sponsored by the Institute of Statistical, Social, and Economic Research (ISSER) at the University of Ghana, Legon, the African and African American Studies Programme at Dartmouth College, the Institute of African Studies at Columbia University, the Center for the Study of Force and Diplomacy (CENFAD) at Temple University, and the Association for the Study of the Worldwide African Diaspora (ASWAD). Logistical support was provided by the Department of Music and Dance as well as the Faculty of Arts, UCC.



*Delegates at the "Global Ghana" conference during one of the panel sessions (photo credit: Dr. Florian Carl)*



*Delegates at the "Global Ghana" conference during one of the panel sessions (photo credit: Dr. Florian Carl)*

## **Collaborative Theatre and Dance Production "Black Water"**

"Black Water" was a collaborate theatre and dance production by the Fringe Ensemble (Bonn, Germany) in collaboration with the Department of Music and Dance as well as the Department of Theatre and Film Studies at UCC. Based on the film script of the Ghanaian author and actor Obuobi Onesiphorus, the production brought together artistes from Germany and Ghana, under the auspices of the Bonn-Cape Coast sister city collaboration.

The project focused on the situation of the Fosu Lagoon whose ecosystem has been gradually destroyed due to climate change and environmental pollution. The play was created under the direction of Frank Heuel, artistic director of Fringe Ensemble, in collaboration with Ghanaian and German artistes. The piece included multilingual scenes, dance-elements by the choreographer and dancer, Margaret Delali Numekevor (Department of Music and Dance, UCC), and video projections. Initially staged in 2015 in Bonn, Germany, the production was staged again in 2016 in Cape Coast on nine separate occasions at the UCC Main Auditorium, the Biodiversity Centre Cape Coast, and the Cape Coast Town Hall. The media partner for the production was Coastal TV in Cape Coast.



*Professor Ato Quayson (University of Toronto, Canada) delivering his keynote address on "Genealogies of Cosmopolitanism: Accra's Oxford Street" (photo credit: Dr. Florian Carl)*



Scenes from the "Black Water" performance at UCC Main Auditorium (photo credit: Ilona Schaal)



Scenes from the "Black Water" performance at UCC Main Auditorium (photo credit: Ilona Schaal)



Scenes from the "Black Water" performance at UCC Main Auditorium (photo credit: Ilona Schaal)

## Production "Nkrumah's Vision for One Africa: The Reality"

The story of Nkrumah has been told and retold in many forms. This production, Nkrumah's Vision of One Africa: The Reality, presented a unique recreation of the story of Nkrumah. It captured aspects of Nkrumah's childhood, his growth, his role in the struggle for Ghana's independence, his relationship with other African countries, his marriage to Fathia and his exile, through a rich tapestry of music, dance and theatre. The four-movement rendition was presented in the framework of a traditional story-telling session.

The production, under the directorship of Margaret Delali Numekevor, was realised with sponsorship from the US Embassy to Ghana. The script for the production was written by Eric Debrah Otchere, a Lecturer in the Department of Music and Dance, who also worked as the stage manager. The piece was choreographed by Kofi Anthonio and Reginald Sackey while the music was composed by Dr. Mawuyram Q. Adjahoe, Torwomenye K. Ansah and Benedict A. Sackey. The show was staged on 31st October and 1st November, 2013 at the School of Medical Sciences Auditorium on the campus of UCC.



Scenes from the production "Nkrumah's Vision for One Africa: The Reality"



Scenes from the production "Nkrumah's Vision for One Africa: The Reality"



Scenes from the production "Nkrumah's Vision for One Africa: The Reality"



Scenes from the production "Nkrumah's Vision for One Africa: The Reality"



Scenes from the production "Nkrumah's Vision for One Africa: The Reality"

### **Department of Theatre and Film Studies' Video Production "Educational Videos on Diabetes Mellitus"**

In August 2015, the Department of Theatre and Film Studies was commissioned by the School of Medical Sciences in UCC to produce a training and educational video on the medical condition, Diabetes Mellitus. The video was produced in both English and Fante languages intended to be used by students of the School of Medical Sciences in their community outreach projects and to be screened at hospital out-patient departments and various diabetes clinics.

### **Performance Production to celebrate "Black History Month"**

The Department of Theatre and Film Studies in February 2015 collaborated with the Embassy of the United States of America in Ghana to organise and celebrate Black History Month. The programme was organised to celebrate and acknowledge the contributions of Black people to sociocultural development and civilisation. The programme involved lectures and performances of drama, music and dance.

### **UNICEF Theatre for Development Project**

In 2012, the Department of Theatre and Film Studies collaborated with UNICEF and the Ghana Health Service to undertake Theatre for Development projects in 18 selected communities in the Central Region of Ghana. The projects focused on three areas of concern with regard to public health. These were, 1) to promote the use of long-lasting insecticide mosquito nets to reduce the incidence of malaria, 2) to encourage hand-washing with soap for the improvement of daily health, and 3) to promote attitudes, habits and activities that will lead to safe delivery of children as well as to encourage exclusive breastfeeding.



### ***Book Project “Harnessing Cultural Capital for Sustainability: A Pan Africanist Perspective”***

This book, edited by Prof. Samuel Awuah-Nyamekye and Prof. Munyaradzi Mawere of the Great Zimbabwe University in 2015, was funded by the Langaa Research and Publishing Common Initiative Group, Mankon-Bamenda, Cameroon. It explores how the African cultural capital, especially its indigenous knowledge, can be tapped to play a central role in fostering development and sustainability on the continent. This way, the Pan-African ideals of collective self-reliance, self-sustaining development and economic growth, the book argues, would be seen to be attainable.

### ***Book Project “Managing the Environmental Crisis in Ghana: The Role of African Traditional Religion and Culture with Special Reference to Berekum Traditional Area”***

This work was authored by Professor Samuel Awuah-Nyamekye in 2014 and funded by the Cambridge Scholars Publishing Ltd., UK. It is a modification of his PhD thesis, “Managing the Environmental Crisis in Ghana: The Role of African Traditional Religion and Culture: A Case Study of Berekum Traditional Area”. The book assesses the nature and level of the environmental problems facing the country and suggests that combining or utilising indigenous knowledge and Western scientific methods could help address the problems.

### ***Book Project “The Hebrew Bible and the Five Books of Moses”***

This book, written by Dr Augustine M. Mensah and published in 2016 by NYAKOD Printing and Publishing Co. Ltd. Cape Coast, looks at the Hebrew Bible as a whole, its composition and how it compares with the Christian Old Testament, the Bible and history, methods for interpreting the Bible, the authors of the biblical books (especially the first five called the Books of Moses), and the discussion of some of today’s most passionate disputes like homosexuality. Regarding homosexuality, the book reveals how the Bible is frequently misunderstood, misquoted, mistranslated, and misused to justify both right and wrong positions on the subject. The book was self-funded and it is the first of a three-volume work on the Hebrew Bible.

### ***Ghana Values Studies: Towards the Realisation of Ghanaian Human Values for Governance and Global Citizenship***

This is a research project Dr. Simon Kofi Appiah in the Department of Religion and Human Values is currently undertaking in collaboration with Prof. Sigrid Müller, Dean of the Faculty of Theology at the University of Vienna, Austria. The study seeks to investigate how people in Ghana, as individuals and as ethnicities, understand values, and what they perceive and/or experience to be implicit and explicit value-orientations in governance and citizenship. This will be achieved through the collection and analysis of data regarding value-changes in Ghana and how they relate to particular social, political, economic, and religious states. This research project has provided Dr. Simon Kofi Appiah with the opportunity to collaborate with scholars at the University of Vienna, who are already engaged in the European Values Studies, an internationally acclaimed research project.

### ***Between Rhetoric and Reality: The State and Use of Indigenous Knowledge in Post-Colonial Africa***

The book presents interesting and insightful discourse on the state and role that indigenous knowledge can play in addressing a tapestry of problems of the world and the challenges connected with the application of indigenous knowledge in enlightenment science-dominated contexts. It is useful to scholars and students in fields of indigenous studies and anthropology, and also in environmental science, social and political ecology, development studies, policy studies, economic history, and African Studies.

### ***History of UCC: Fifty Years of Excellence in Tertiary Education, 1962-2012***

The book authored by three lecturers in the Department of History, UCC, was written to commemorate the fiftieth anniversary of the University of Cape Coast in 2012. It chronicles the history of University of Cape Coast, from 1962 when the dream of Osagyefo Dr. Kwame Nkrumah and his Convention People’s Party government to establish a third university in Ghana crystallised up to 2012. The book investigated the various developmental stages the University has gone through, focusing on both the achievements and challenges of the institution during the period under consideration.



## *History of CHASS: Fifty Years of Providing Quality Leadership in Secondary Education in Ghana, 1962 -2012*

This book is about the history of the Conference of Heads of Assisted Secondary Schools (CHASS) in Ghana, written by four lecturers in the Department of History in UCC. The book was commissioned for the commemoration of the fiftieth anniversary of CHASS. The Central Regional Executive of CHASS approached some lecturers in the Department of History in 2012 to reconstruct the history of the association for the celebration of their golden Jubilee. CHASS funded the research and the publication of the research outcome as a book. The book provides insight into the history of the Association, the objectives of the Association, the successive leaders of the Association, the achievements, and challenges of the Association during the fifty years of its existence.

## *Africa and the First World War: Remembrance, Memories and Representations after Hundred Years*

The year 2014 marked the centenary of the First World War (WWI), otherwise known as the Great War. Though a European war, the African continent became one of the theatres of the war due to colonisation. Africans were also recruited as soldiers and carriers to participate in the war at different war places throughout the world. In 2014, the European powers commemorated the centenary of WWI without recognising the African participation. The Department of History, therefore, deemed it proper to organise an international conference, which took place at UCC from 28th -30th October, 2015. At the conference, scholars from Africa and beyond as well as Ghana Armed Forces members presented papers on the African participation in WWI. The conference was sponsored by the Ghana Armed Forces and other organisations. Selected conference papers have been edited and submitted to Cambridge Publishers for publication as an Anthology forthcoming in 2017.

# *DESCRIPTION OF CREATIVE PROJECTS*



## *Application of International Law in Ghana*

The major objective of this study is to examine the application of International law in the Ghanaian Legal System. Specifically, the study explores the knowledge, attitudes and application of international law by judges and lawyers in Ghana. The research links into the wider global trend towards the internalisation of legal systems in a liberalised world.

Two data collection instruments were designed to gather primary data for this study. They consist of questionnaires targeted at judges of the superior courts and legal practitioners in Ghana. The two questionnaires were semi-structured and designed to elicit information from the respondents on their knowledge, attitudes and practice of international law. The Statistical Product for Service Solutions (SPSS) version 17 will be used to process and analyse the quantitative data using descriptive and inferential statistics. The qualitative data will be analysed using legal research tools of analysis. Content analysis of the open-ended questionnaire will also be done to inform the discussion of findings.

Copies of the questionnaire are being analysed. Preliminary conclusions indicate a large gap in the knowledge base of many judges and legal practitioners in Ghana. The attitudes of many of the respondents indicated a cautious engagement with international law linked in part to the dearth of international law training in the country. The analysis of reported decisions of the court indicates that many judges do not have a robust understanding of international law issues.

## *The Ghanaian Council of State: Free & Fit to Counsel*

'The Ghanaian Council of State: Free & Fit to Counsel?' in *A Commitment to Law, Development and Public Policy: A Festschrift in Honour of Nana Dr. S.K.B Asante, Richard Frimpong Oppong and William Kissi-Agyebeng* (Eds), Wildy, Simmonds & Hill Publications (November, 2016). The research was conducted between December, 2015 and June 2016. The objective of the paper was to assess whether the Council of State sufficiently embodies democratic principles such as transparency, impartiality, and accountability as well as whether it is necessary in Ghana's 4th Republic. The paper concludes that there are significant concerns regarding the governance of the Council of State. The paper highlights that its usefulness is questionable and takes the position that if the Council of State is to remain in existence, then the law and policy governing it should urgently be reformed.

## *Recognition of States and Governments*

'Recognition of States and Governments' in *Introduction to Public International Law*, Shilpa Jain (ed), Cambridge Scholars Publishing (December, 2015). The research was conducted between April and October 2015.

This is a textbook chapter with the objective of introducing the basics of international law, regarding the international recognition of both states and governments, to undergraduate political science, international relations and law students.

## *The Ethnic Factor in the Political Life of the People of Asuogyaman*

The ethnic factor or ethnicity is noted to play a key role in protracted conflicts, which impact the social and political landscapes of modern Africa and most parts of the world where nation abound. We, therefore, examined the political behaviours in the Asuogyaman District in Ghana in order to unravel the complexities of cycles of conflict and resulting peace-building strategies.

The study proved that the ethnic factor did not influence the political life of the people of Asuogyaman as found else by authors such as Agyeman (2008), Cunningham (2001, 1998), and Cornor (1994). The enemy system and Frustration-Aggression theories which were employed did not hold sway as it did elsewhere due to the availability of other mediums of redress made available to the people of Asuogyaman.

The paper adds to the literature on ethnicity and its interaction with politics and indicates ways through which ethnic political strife can be dealt with to promote development in Ghana.

## *Labour Disputes and Compliance with Labour Laws in Ghana*

Labour disputes have become the order of the day as regarding Ghana's labour front in recent times. It is not uncommon to find many labour unions in the country engaged in confrontation with government over welfare matters ranging from salary arrears to other conditions of service that labour unions envisage unwillingness of government to honour. Since 2010, there have been several occasions where labour unions such as the University Teachers Association of Ghana (UTAG), Tertiary Education Workers Union (TEWU), and the Federation of Universities Senior Staff Association of Ghana (FUSSAG), have gone on strikes just to press home their demands. However, the Labour Act 2003, Act 651 was enacted to guide, regulate and resolve these labour disputes.

Despite the institutionalisation of laws, strikes, demonstrations etc., other forms of labour disputes continue to persist in the country. The objective of this research is to ascertain whether labour unions in Ghana adhere to the labour law and to find the bottlenecks that impede labour unions ability to comply with these laws.

The research sought to unravel the mysteries surrounding these labour disputes bedevilling the labour sector in Ghana.

## *Human Rights Abuses of Mental Patients in Ghana*

Human rights are rights assigned to and enjoyed by every human being by virtue of the fact that they are human, irrespective of their race, creed, values, mental or physical state. The Universal Declaration of Human Rights and other international conventions such as the International Covenant on Economic, Social and Cultural Rights (ICESCR) clearly cover health rights and have been adopted to protect and enforce the respect of these rights that are fundamental to human existence in many countries around the globe.

However, in Ghana, rights of the mentally challenged have been sidelined and abused on several fronts with such abuses prevalent in the media. Even though the Mental Health Decree (1972) and Mental Health Act 2012, (Act 846), clearly stipulated these rights which the mentally disabled individuals are entitled to, their rights are trampled upon with impunity by the state agencies, private organisations, prayer camps or individuals who are supposed to provide care to these people. These abuses include limited access to psychiatric healthcare institutions, relatively less governmental provision and funding for general hospitals and primary healthcare based services which are concentrated in the capital cities leaving much of the rest of the population in rural areas with almost no provision, unwarranted admissions, and wanton mistreatment of people who are locked away in institutions for decades, have persisted. There is also inadequate qualified personal, low inadequate financial commitment from government making it impossible for the mentally challenged patients to have access to drugs, feeding, sleeping spaces and other necessities provided for them. This paper set out to investigate the abuses as well as reasons behind the abuses of these rights.

## *Trust, Risk and Uncertainty in Medicinal Transactions in Sub-Saharan Africa: Integrating Behavioural Game Theory and Ethnography to Develop a Robust Analytical Framework to Address a Major Global Public Health Challenge*

Medicines are at the centre of a major global public health crisis. Widespread counterfeiting and unprecedented global traffic of pharmaceuticals have created significant trust problems for patients and others, particularly where regulation is weak, with serious risks for individual and public health. We propose to develop a robust analytical framework to understand the mechanisms that foster the production of trust in medicinal transactions in sub-Saharan Africa. Our question is: how, under conditions of uncertainty and informational asymmetry, do actors (consumers and providers) come to trust and distrust particular medicines, and how does this shape practice? Our goal is to bring together the richness of ethnographic enquiry with the powerful analytical approaches offered by Behavioural Game Theory in order to address this pressing global public health problem. This project seeks to conduct a pilot and feasibility study in Ghana and Tanzania; collect preliminary data to underpin theoretical and methodological development; build/consolidate international academic and stakeholder partnerships; and develop local research capacity. This is particularly, important given the theoretically-novel and ambitious nature of the proposed larger study and the new international as well as inter-disciplinary research consortium we are building.



*The research team (investigators and research assistants) in a group photograph after a training workshop.*



## *Establishment of an International Research partnership between Cape Coast University, Ghana and University of Bradford, UK in the field of Human Resource Development for Public Sector Reform*

Ghana's on-going reform is contingent on the institutional, technical and human resource development (HRD) capacity arrangements governing its implementation. The topic of reform is also of interest for the researchers. The research component will be concerned with the role of HRD for enhancing public sector reform (PSR) and decentralisation. The capacity building component of the project involves two workshops to enhance the research capability of the colleagues at the University of Cape Coast as well as the organisation of two one-day conferences in both UK and Ghana. The final component is the establishment of virtual forum for database, and research outputs as well as planned exchange visits to benefit both parties and provide a robust foundation for the establishment of the international partnership between the two universities.



*Prof. Farhad Analoui (University of Bradford, UK) facilitating one of the capacity building workshops on Qualitative Research Methods and Academic Writing Skills at the Faculty of Social Sciences Conference Room, UCC*



*Prof. S. K. Annim (UCC) facilitating one of the capacity building workshops on Quantitative Research Methodology at the Faculty of Social Sciences Conference Room, UCC*

## *Mobile phones and youth in sub-Saharan Africa*

This project is a multi-country research involving Ghana, Malawi and South Africa, and is aimed at exploring how the rapid expansion of mobile phone usage impact on young lives in sub-Saharan Africa. The project, focuses specifically, covers a wider range of phone-related issues, including changes in gendered and age patterns of phone use over time, phone use in building social networks (for instance to support job search), impacts on education, livelihoods, health status, safety and surveillance, physical mobility and possible connections to migration, youth identity, image, and questions of exploitation and empowerment associated with mobile phones. The Ghana component involved eight contrasting study sites in two ecological zones (forest and coastal). Mixed-method, participatory youth-centred studies was used and more than 1,500 questionnaires were administered together with about 500 interviews in Ghana.



*The lead country collaborator, Prof. A.M. Abane, in a daily pre-fieldwork meeting with research assistants in Sunyani*



*The lead country collaborator, Prof. A.M. Abane, in a dissemination workshop with national stakeholders*

## *What has Poverty Got to do with it? Asset-based Approach of Household Access to Improved Sanitation in Ghana*

This project investigates antecedents to demand for household sanitation in Ghana. A mixed-method approach, relying on the 2011 Ghana Multiple Indicator Cluster Survey (MICS) and primary qualitative data generated from individual and group interviews, was employed. The aim was to ascertain the role of household assets (wealth) in access to improved sanitation in Ghana. The study established that although wealth positively influenced household ownership of improved sanitation, the effect is strongly noticed only at the pinnacle of wealth quintiles (richest households). From the qualitative data, it was realised that, beyond poverty, a mix of cultural, social, political and economic nuances influenced and somehow perpetuate low access to improved sanitation in Ghanaian households. Means targeting of the poor and application of social marketing of sanitation in both rural and urban areas can help trigger awareness and demand for improved sanitation in Ghana.



*Dr. Simon Mariwah, the Principal Investigator in the poverty and sanitation project*

## *Cashew Cultivation, Access to Land and Food Security in Brong-Ahafo Region, Ghana: Preventing the intergenerational transmission of poverty*

This research aimed to investigate the implications of changing agricultural land use from food production towards increased cashew cultivation for food security and poverty alleviation in the Jaman North District, Brong-Ahafo Region of Ghana. Based on qualitative, participatory research with a total of 60 participants, the research found that increased cashew production had led to improvements in living standards for many farmers and their

children in recent years. Global demand for cashew is projected to grow rapidly in the immediate and near future, and cashew-growing areas of Ghana are well placed to respond to this demand. Cashew farmers, however, were subject to price fluctuations in the value of Raw Cashew Nuts (RCN) due to unequal power relations with intermediaries and export buyer companies as well as global markets, in addition to other vulnerabilities that constrained the quality and quantity of cashew and food crops they could produce. The expansion of cashew plantations was leading to pressure on the remaining family lands available for food crop production, which community members feared could potentially compromise the food security of rural communities and the land inheritance of future generations.



*Some community members in a participatory mapping session facilitated by investigators*

## *A Transnational Study of the Relevance of LMD/BMD Reforms to the Socio-economic Development of West and Central African Countries: Case Study of Ghana, Sierra Leone, Cameroon and WAEMU Countries"*

The project reviewed the strengths and weaknesses in policies and practices for higher education provision and assessed its impact on the social and economic development of graduates and the nations in West and Central Africa. Relevant recommendations were made for possible reforms in higher education provision in the sub-region of West and Central Africa. Our team took charge of the Ghana component of the project, which has been successfully completed.

## *Comparative Study of Police Training Practices in the US and Ghana*

This project is part of the collaboration between the Kennesaw State University (KSU), USA, and UCC, Cape Coast, Ghana. The primary objective guiding the project is to compare police training in the US and Ghana. Specifically, training protocols in the US and Ghana are being examined thoroughly, so that best practices can be shared between these two countries. Two graduate students – one from KSU and the other from UCC – are being sponsored by the project to use the data so far gathered to inform their dissertations. The project targets are being met and it is expected to be completed by the end of the first quarter of 2017.

## *Investigating Technology-mediated Faculty-Student Interactions among Graduate Ghanaian University Students*

This is a CODESRIA sponsored project involving three universities – The University of Ghana, Legon, Ghana; the University of Cape Coast, Cape Coast, Ghana; and the Delaware State University, USA. The main objective driving this project is to investigate graduate students' preference for faculty-student interaction and the learning outcomes associated with their preferred medium of interaction. The project aims to contribute to understanding the role of digital technologies in graduate teaching in Ghana. Such understanding is critical in providing leverage for the use of technologies in higher education for a more effective teaching and learning practices in Ghana. The project is presently at its final stage, that is, validation and dissemination workshops for knowledge sharing purposes.

## *International Research Partnership on Gender between the University of Cape Coast, Ghana and the University of Sheffield, UK*

Gender-based violence and its causes are universal problems. Locally, the issue has attracted much research attention in Ghana since the late 1980s when it was first recognised as a social problem. Like many other issues of this nature, gender-based violence, especially, within the context of relationships and the family more generally, has long been a taboo for public discussion and intervention in Ghana. However, within the last 30 years, gender-based violence has become an issue for social and policy concern, mainly as a result of campaigns by gender activists, women lawyers and non-governmental organisations (NGOs). However, gender-based violence, targeted at young girls in the country in particular, remains prevalent. Hardly does a week pass

by without the media reporting on cases of gender-based violence in the form of physical violence, rape, defilement or other forms of sexual harassment in various spheres – be it the home, school, church or within peer relationships. Within this context, this study sought to explore how gender and sexual identities develop and change in children from early childhood into adulthood. It further sought to assess the extent to which these identities provide a facilitating environment for gender-based violence for girls and young women as well as examine how girls and young women experience power and violence in their relationships with the opposite sex. The study adopted a multiple-method research design within a qualitative framework. It drew on the voices of 365 participants made up of children, young people and parents from four study sites in the Central Region of Ghana to explore the issue. The project also had a capacity building component involving two workshops conducted in 2014 and 2015 aimed at enhancing the research capacities of junior faculty and graduate students of the University of Cape Coast in the area of qualitative research methodologies and data analysis.



*Pictures from some study sites with some children and Research Assistants involved in the study.*



## *Gender equality and women's rights in rural livelihoods: Evidence from selected Asian and African countries – 2016*

The objective of the project was to understand the various agricultural production relations systems and how they shape women's response to interventions designed to support rural livelihoods. This is informed by the fact that existing provisions fail to promote women's livelihood security. The achievements included the recruitment of a student intern to build her capacity in conducting gender research – Ms. Loretta Baidoo. Initial findings have been disseminated in an international workshop and a policy engagement in Faisalabad, Pakistan.



*FGDs in Nkrankrom, Sunyani*



*Dissemination workshop in Pakistan*

## *Gender Orders and Higher Education in the University of Cape Coast College of Distance Education - 2016*

The objective of the project was to understand the gender orders and ensuing challenges facing female students enrolled in UCC's Distance Education Programme. This is in recognition of the fact that female students have been confronted with gender-specific needs. The achievements included the capacity building of CoDE staff as research assistants in conducting gender sensitive research.





## *Rural-Urban Linkages: Precarious Urban Work and precarious Rural Livelihoods Connections in South Africa and Ghana - 2016*

This project sought to understand the connections between precarious work in urban areas, and precarious livelihoods in rural areas. The project recruited a student intern and has built her capacity in conducting gender research – Ms. Lalaki Hikimatu Awudu



*Data collection at Tizza, Upper West Region*

## *Men, Gender Equality, and Parental Leave Systems – 2015*

As part of the project, CEGRAD hosted Prof. José Andrés Fernández Cornejo from Universidad Complutense de Madrid, Spain, from 12th to 23rd October, 2015. Professor Cornejo is an Associate Professor of Economics and co-director of the research group known as the Economic Analysis of Diversity and Equality Policy. The purpose of his visit was to explore the possibility of a collaboration between UCC and Universidad Complutense de Madrid. During his stay, Professor Cornejo delivered a public lecture on Men, Gender Equality, and Parental Leave Systems.



*Public lecture on the project title*

As part of the project, CEGRAD hosted Prof. José Andrés Fernández Cornejo from Universidad Complutense de Madrid, Spain, from 12th to 23rd October, 2015. Professor Cornejo is an Associate Professor of Economics and co-director of the research group known as the Economic Analysis of Diversity and Equality Policy. The purpose of his visit was to explore the possibility of a collaboration between UCC and Universidad Complutense de Madrid. During his stay, Professor Cornejo delivered a public lecture on Men, Gender Equality, and Parental Leave Systems.

## *Gender Equality and Women's Rights in Rural Livelihoods in Ghana and Pakistan - 2015*

The project sought to understand the gendered access to rural livelihood resources like land, labour and capital. This is in view of gendered rural poverty. The international workshop was hosted by CEGRAD. The project provided insights for a second phase.



*Field Work*



*Dissemination Workshop*

## Organising Non Standard Workers in Ghana, South Africa and India: Domestic Workers - 2014

The project sought to understand the unique social relations, vulnerabilities and needs that influence the shape and character of organising among domestic workers in Ghana. International dissemination workshops have been held in Ghana and South Africa.



Dissemination workshop hosted by CEGRAD

## Organising Non Standard Workers in Ghana, South Africa and India: Oil Palm Plantation Workers - 2014

The objective of the project was to understand workers' collective agency and the extent to which trade unions are positioned to reclaim their traditional representation clout. This is in view of the gap created by growing inadequacy of the traditional industrial relations actors. International dissemination workshops have been held in Ghana and South Africa.



Field trip to Ghana Oil Palm Development Company, Kwae

## Evaluation of Gender Aspects of Agricultural Intensification Practices in Northern Ghana

The project sought to understand gender issues surrounding the adoption and adaptation of agricultural interventions in the three Northern regions of Ghana. Findings have been disseminated in a workshop and a technical report has been produced. ned to build the capacity of all who are interested in mediation as a conflict management strategy. The guide was designed initially to prepare National Peace Council staff for the 2016 post-election issues but can be used for all contexts and situations.





## *Doing Mediation: A guide for Practitioners*

This 55-page guide was developed following a review of mediation strategies in several contexts. It presents hands-on exercises in enriching texts designed to build the capacity of all who are interested in mediation as a conflict management strategy. The guide was designed initially to prepare National Peace Council staff for the 2016 post-election issues but can be used for all contexts and situations.



*Interaction of participants regarding the role of mediation in conflict management*

## *Training Manual for Strengthening the Capacity of Traditional Authorities and Religious Leaders in Conflict Management and Peace Building*

Sponsored by the UNDP through the National Peace Council, this project sought to prepare a comprehensive manual to train traditional authorities and religious leaders on conflict management and peace building. This was derived from the fact that a major finding from an earlier research on mapping violent conflicts in Ghana revealed that chieftaincy and religion were major sources of violent conflicts in Ghana. The manual has four modules divided into various sessions. There are also many activities designed for practical exercises.



*Interaction with traditional authorities and religious leaders*



## *Mapping violent conflicts in Ghana*

This research aimed to map violent conflicts in Ghana between 2007 and 2012. Violent conflicts were identified as reported in the two major newspapers during the period and validated through interviews with the regional police command. Focus group discussions and key informant interviews enabled the research team to identify the protagonists in the conflicts, their interests, current status of the conflict, mediation efforts and the prospects for peace. An online version of the book is available at [www.mint.gov](http://www.mint.gov).

Review of Inter-party Dialogue Mechanisms in Ten West African Countries Supported by IDEA, this research reviewed report from ten West African Countries on attempts and efforts towards improving the electoral systems in those countries. Attention was focused on inter-party dialogue as a strategy for improving on transparency and deepening democracy in those countries.

## *Exploring the Role of CSOs in Conflict Prevention and Management in Northern Ghana*

With the support of DRIC, this research explored the role of Civil Society Organisations (CSOs) in conflict prevention, management and resolution (CPMR) in northern Ghana. An earlier study by the Peace and Development cluster at the Institute for Development Studies (IDS) to map conflicts in Ghana identified CSOs as key stakeholders in conflict transformation in northern Ghana. Subsequently, this research examined the specific roles of CSOs in CPMR in northern Ghana focusing on the categories of CSOs and the different roles they performed along the conflict cycle. Three broad categories of CSOs namely Church-based, Community-based and NGOs are operating in conflict prevention, management and resolution (CPMR) in northern Ghana. CSOs have contributed meaningfully to reducing the recurrence of conflicts in northern Ghana.

## *Life-course Approach to Health Inequalities*

Inequalities in health constitute a global public health challenge. The mechanisms through which inequalities in health is produced is not clearly understood. The goal of the project is to use longitudinal data across three generations (adolescents, parents and grandparents) to study how life-course circumstances produce inequalities in health behaviour and health.

## *Implementation of Sexuality Education Policies and Curricula in Developing Countries: A Multi-country Study*

Adolescence is a period of transition characterised by health compromising behaviours, including sexual and reproductive health behaviours, which have implications for their health both in adolescence and in adulthood. The main objective of this project was to conduct a large-scale analysis of policies and curricula in four low and middle-income countries (Peru, Kenya, Ghana and Guatemala), with the ultimate goal of improving provision of comprehensive sexuality education in schools.

## *Review of Ghana's Adolescent Reproductive Health Policy*

Ghana's adolescents' reproductive health policy has been in existence since 2000. Over the past one and a half decade, a lot of social, economic, health and developmental changes have occurred both in Ghana and globally. The goal of the project was therefore, to revise the policy to meet these developmental changes in order to make it relevant for interventions, which are aimed at addressing the sexual and developmental needs of young people in Ghana.

## *Development of Implementation Plan for Ghana's Adolescents Reproductive Health Policy*

The goal of the project was to develop an implementation plan for the revised Ghana's Adolescent Reproductive Health Policy to guide the implementation of the policy among stakeholders.

## *Mid-term Population Based Survey of the Feed the Future Intervention in Brong Ahafo, Upper East, Upper West and Northern Regions of Ghana*

To address some of the challenges in food shortages and the geographic disparities in development indicators, a number of development partners have embarked on programmes in the Brong Ahafo, Northern, Upper East and Upper West regions of Ghana. One of them is the Feed The Future (FTF) Initiative, which begun in 2009 when President Obama assumed office as the President of the US. The goal of the project is to conduct mid-term evaluation (MTE). Specifically, the MTE was to assess the outcomes of the FTF interventions. The evaluation was aimed at generating statistically viable estimates for key FTF nutrition and poverty performance indicators; measure progress made towards meeting FTF output/outcome indicators; and providing evidence for making informed management decisions on the future needs, direction, and investments for the development of the maize, rice and soyabean value chains in Ghana.

## *Graduate Enterprise Development Initiative*

The Graduate Enterprise Development Initiative (GEDI) is set to train about 300 young graduates between the ages of 18 and 35 to set up and manage new enterprises in agro-processing for export and to feed local markets and industries, support 50 of these entrepreneurs with up-to GHC100,000.00 (USD22,000.00) grant to run businesses, connect young entrepreneurs to continuous mentorship from experienced businesses and technical experts in agro-business promotion; and conduct continuous monitoring and evaluation of implementation to ensure there is value for money. The outcome of the project is that 75 young graduates from various fields in Ghana will be trained in entrepreneurship skills in agro-processing each year, and 20 young graduates will be granted up-to GHC100,000.00 (USD22,000.00) to start agro businesses in the export sector each year.



## *Universities, Entrepreneurship and Enterprise Development in Africa*

The project seeks to develop the entrepreneurial spirit of students through the use of practice-oriented teaching and also to encourage collaboration between industry and academia; organise a business-plan competition that focuses on identifying 'Green' business proposals that are environmentally friendly; support three business plans annually from members of university community with EUR10,000,000 sponsored by German Investment and Development Corporation (DEG); support one green business start-up with EUR10,000,000 sponsored by German Development Corporation (GIZ); and provide continuous monitoring of projects to ensure efficient and correct application of the funds. Thus, the project hopes to increase the employability of students by developing the entrepreneurial mindset of students through entrepreneurship training. The programme has also nurtured ideas of students by hosting student businesses at the UCC Business Incubator. Whilst implementing the project, it is expected that UCC will build partnerships with at least 50 businesses so as to enhance practice-oriented teaching.

## *Teaching for Development. Entrepreneurship and Sustainable Economic Development in Africa*

The project aimed at developing the entrepreneurial spirit of students through the use of practice-oriented teaching and also to encourage collaboration between industry and academia; supporting three business plans annually from members of university community with EUR10,000,000 sponsored by German Investment and Development Corporation (DEG), providing continuous monitoring of projects to ensure efficient and correct application of the funds, and encouraging practice-oriented teaching in African Universities.



A photograph of three young women standing outdoors, smiling and looking at a book together. The woman in the center is holding the book, which has 'Ghana' written on the cover. The woman on the left is wearing a blue top, and the woman on the right is wearing a red top. The background is a blurred green outdoor setting.

# CENTRE FOR INTERNATIONAL EDUCATION

## *Introduction*

*The Centre for International Education (CIE), University of Cape Coast, was established to promote, support and coordinate all facets of international education activities in the University. These activities include international students and staff exchanges, research collaborations and publications, and information sharing, all aimed at enhancing the international image of the University.*

*Over the years, the Centre had fostered links with institutions of higher learning from the USA, China, UK, Sweden, Germany, Liberia, Nigeria and Senegal, among others.*

*The Centre offers specialized support services for inbound and outbound exchange students and staff on issues including, but not exclusive to, orientation, admission, enrollment, accommodation, pastoral care, pre-departure briefings and post-return debriefings for inbound and outbound exchange students and staff.*



## Functions

The Centre:

1. manages all matters and programmes relating to international education.
2. serves as an advisory unit to all academic departments on exchanges and collaborations.
3. serves as a service provider on campus to all international and visiting students, faculty members and staff.
4. is responsible for the development of Memorandum of Understanding or partnership agreements with institutions in and outside Ghana.
5. facilitates the exchange of staff, faculty and students of partner institutions and vice-versa.
6. organises international workshops, seminars and conferences.

## SUMMARY OF MAJOR FUNDED RESEARCH

Grant Type	Title of Project	Principal Investigator(s)/ Stakeholders	Department(s)	Source of Funding	Total Amount	Status of Project
Consultancy Project	Developing a Business and Policy Centre for Eco-Innovative Micro Small and Medium Sized Enterprises in the E-Waste Sector in Ghana	Prof. (Mrs.) Rosemond Boohene (UCC, Ghana)	Centre for International Education, UCC, Ghana	EU/UNEP/ UNDP	GHC924,300.00	2/3 Complete

### Summary of Project

The Switch Africa Green project implemented by the University of Cape Coast and its partners, University of Northampton (UoN), United Kingdom and United Nations University (UNU), Germany began in July 2015, had the overall objective of facilitating a green economy for the e-waste value chain by creating income generating opportunities and reducing environmental degradation through improved resource recovery and waste prevention and management in the Greater Accra (Accra and Tema) and Ashanti Regions (Kumasi). Specifically, the project sought to:

- promote sustainable patterns of consumption and production through a resource efficient e-waste management;
- provide comprehensive consulting and support for establishing eco-innovative Micro, Small and Medium-sized Enterprises (MSMEs) through identification of green technologies and building capacity on eco-entrepreneurship;
- contribute to poverty alleviation by improving working and living conditions of workers and communities by reducing

environmental and health impacts of the improper recycling of e-waste; and

- foster dialogue with decision-makers on policies enabling a green economy in the e-waste management sector and support informed-decision making.

This project is being implemented at a time when the e-waste streams generated by Micro, Small and Medium-sized Enterprises (MSMEs) in Ghana are hazardous, complex and expensive to treat in an environmentally sound manner. Moreover, the e-waste bill passed in July 2015 after the commencement of this project stipulates how the e-waste value chain is to be regulated and managed in Ghana.



*Prof. Rosemond Boohene facilitating workshop session*



*Prof. Rosemond Boohene facilitating workshop session*



*Snapshot of sample waste*









**UCC MAIDEN CALL  
FOR RESEARCH SUPPORT  
GRANTS AND BEST  
RESEARCHER AWARDS**



*Key thrust 5 of the 2012 – 2017 Strategic Plan of UCC enjoins the University to promote active research that is aimed at bridging the gap between academia, industry and policy-makers. To achieve this, the University instituted the research awards and grants in 2005, which was in line with the Vice Chancellor's (Prof. D. D. Kuupole) vision for the University, for its faculty members.*

*In these connections, an equal opportunity platform was created by the University through DRIC for faculty members to apply for limited research grants to undertake high-class evidence-based research in areas of relevance to national development. Following a competitive bidding process, five faculty members benefitted from the research grants (GHC20,000.00 to three and GHC15,000.00 to two faculty members, respectively). The grantees have completed their research undertakings, submitted their reports and policy briefs to the University.*

Below is a table showing the 2015 research grant winners: The maiden calls for research grants and awards were concluded with a Research Awards and Grants (RAG) ceremony organised by DRIC on Tuesday, 26th April, 2016 at the UCC Auditorium to honour its faculty members for demonstrating excellence through their research activities/work. The rationale for this ceremony was to provide a platform for the two categories of beneficiaries (grantees and awardees) to share their research findings.

NO.	NAME OF GRANTEE	TITLE OF RESEARCH	ADDRESS
1	Prof. Elvis Asare-Bediako	Incidence of Viral Diseases of Okra ( <i>Abelmoschus Esculentus</i> L.) In the Three Agro-ecological Zones of the Central Region and Identifying Resistant/Tolerant Varieties	Department of Crop Science, School of Agriculture, College of Agriculture & Natural Sciences
2	Dr. Samuel Acquah	A Study of Insulin Resistance in Rat Malaria	Department of Medical Biochemistry, School of Medical Sciences, College of Health and Allied Sciences
3	Dr. Patrick Osei-Kufour	Mapping of Civil Society Organisations (CSOS) involved in Conflict Prevention, Management and Resolution (CPMR) work in Ghana	Institute for Development Studies, Faculty of Social Sciences, College of Humanities & Legal Studies
4	Dr. Simon Mariwah	What has Poverty Got to do with it? Asset-based Approach to Household Access to Improved Sanitation in Ghana	Department of Geography & Regional Planning, Faculty of Social Sciences, College of Humanities & Legal Studies
5	Dr. Baah Sefa-Ntiri	Application of Nanotechnology to Underground Water Treatment, Assisted by Laser Light Techniques	Department of Physics, School of Physical Sciences, College of Agriculture & Natural Sciences



To further promote the conduct of rigorous research that is of national and global relevance, DRIC opened a bid for a call for awards of excellence in research. Three categories of awards were made available, namely Outstanding Researcher Award (ORA), Best Evolved Researcher Award (BEEdRA) and Best Evolving Researcher Award (BERA). Following an assessment of the submissions (9 for BERA and 5 for BEEdRA), two members of faculty emerged for the awards of BEEdRA and BERA.

NO.	NAME OF AWARDEE	TITLE OF AWARD	ADDRESS
1	Dr. David Teye Doku	<b>Winner of Best Evolved research Award (BEEdRA)</b> (GHC10,000.00, Citation and Certificate)	Department of Population & Health, Faculty of Social Science, College of Humanities & Legal Studies
2	Prof. Akwasi Kumi-Kyereme	<b>First Runner-up (BEEdRA)</b> (Citation and Certificate)	Department of Population & Health, Faculty of Social Science, College of Humanities & Legal Studies
3	Prof. Ernest E. Abano	<b>Second Runner-up (BEEdRA)</b> (Citation and Certificate)	Department of Agricultural Engineering, School of Agriculture, College of Agricultural and Natural Sciences
4	Dr. Hope Pius Nudzor	<b>Winner of Best Evolving Researcher Award (BERA)</b> (GHC5,000.00, Citation and Certificate)	Institute for Educational Planning & Administration, College of Education Studies
5	Dr. Ernest Teye	<b>First Runner-up (BERA)</b> (Citation and Certificate)	Department of Agricultural Engineering, School of Agriculture, College of Natural & Agricultural Sciences
6	Dr. Ing. Samuel Kofi Tulashie	<b>Second Runner-up (BERA)</b> (Citation and Certificate)	Department of Chemistry, School of Physical Sciences, College of Natural & Agricultural Sciences

# AWARDS AND ACHIEVEMENTS



## UCC Chancellor Wins Prestigious Award

---

Dr. (Sir) Sam Esson Jonah

The Chancellor of the University of Cape Coast, Sir (Dr.) Sam E. Jonah, has received a lifetime achievement award at the West African edition of the Ernst and Young (EY) World Entrepreneur of the Year, held in Lagos, Nigeria on Friday February 5, 2016. The EY Entrepreneur Awards recognises the world's most successful and innovative entrepreneurs by identifying and acknowledging their outstanding achievements within successful growing of dynamic businesses.

Sir Jonah, who is also the Executive Chairman of Jonah Capital, an equity fund based in Johannesburg, South Africa, is one of Africa's most prominent businessmen, a giant in global business, and internationally recognised as a leading business executive. He was educated at Adisadel College in Ghana, Camborne School of Mines in Cornwall and The Imperial College of Science & Technology, London.

This adds to the numerous list of awards and honours bestowed on Sir Jonah by both local and international organisations and universities.

**International award to  
Dr. Ernest Teye: INTRA-ACP MOBILITY: SHARE  
Capacity**



This award was given to Dr. Ernest Teye by E.U. Intra-ACP mobility under the share capacity to build capacity for quality graduate training in agriculture in African Universities to conduct research, teach and build capacity. This came as a result of his outstanding contribution in Food Engineering.

**International Award to  
Dr. Julius K. Hagan: YOUNG PROFESSIONAL SCIENTIST**



Dr. Julius K. Hagan, a senior lecturer of the Department of Animal Science, School of Agriculture, UCC was awarded the 3rd best young professional scientist in Africa. His research was on *"Introducing heat-tolerant genes into exotic chicken for improved egg production under hot and humid environments"*. It was a 3rd African-wide competition for women and young professionals in science organised by **CTA/FARA/IFS/ANAFE/RUFORUM/NPCA/AGRA**. The award came with a cash prize of **USD 1500.00**.

The objective of the competition was:

1. to recognise and reward the contributions of African women scientists and young professionals who are involved in pioneering an innovative research, technology development and engineering;
2. to raise awareness of the need for valuing and sustaining the engagement of women and young professionals in science and facilitating their contribution to Africa's socio-economic transformation.

**Dr. Julius Kofi Hagan Nominated  
as CTA Top 20 Innovators in  
the World**



Dr. Julius K. Hagan, a senior lecturer at the Department of Animal Science, School of Agriculture, University of Cape was awarded as one of the top 20 innovators in the world as his innovation *"More productive local chickens: all in the genes"* was selected as one of the top 20 innovations that benefit smallholder farmers. This competition was organised by the CTA. The competition was aimed at unearthing and boosting the awareness of the many innovations that research organisations, universities, extension services and farmers have developed and are being used by smallholder farmers. The winning top innovators were each given a grant of €5,000 to document and elaborate their innovative projects and invited to a cross-learning workshop to finalise their posters, brochures and guidebooks.



### *Prof. Douglas Agyei Wins International Award*



An Associate Professor at the Department of Science and Mathematics Education, Prof. Douglas D. Agyei has been honoured at the 25th International Conference of the Society for Information Technology and Teacher Education (SITE) held on March 17-21 at Jacksonville, Florida in the USA in 2014.

Prof. Agyei's paper on the topic, "Using Technology Pedagogical Content Knowledge (TPACK) Development to Enhance Learning Outcomes" won one of the five TPACK paper awards for 2014. Out of over 3000 papers presented for the conference, 86 TPACK related papers were shortlisted from which five were awarded. His paper was also singled out as the highest ranked by the reviewers.

### *Dr. (Mrs.) Georgina Yaa Oduro Wins Award*



Senior Lecturer at the Department of Sociology and Anthropology and a Fellow of the African Doctoral Dissertation Research Fellowship (ADDRF), Dr. Georgina Yaa Oduro, was awarded the best presenter on African Women's Health Issues at a conference organised by the African Population and Health Research Centre (APHRC) in Kenya from July, 15 to 17, 2013. The conference, which was held at the Hilton Hotel in Nairobi, was on the theme, 'Scientific Symposium for Emerging Scholars in Health'. The award was granted by the internationally recognised publisher Taylor and Francis.

The presentations that won Dr. Mrs. Oduro the enviable award were based on the following co-authored articles:

- (a) "From Exclusive Breast Feeding to Complementary Feeding: Narratives from mothers in Cape Coast" (Oduro G.Y. and Sika-Bright, S) and
- (b) "Abortion: it is My Own Body: Narratives from females about influences on their abortion decisions" (Oduro G.Y. and Otsin A.M).

A condition attached to the award is that Dr. Oduro should update the award-winning papers for publication in the journal, 'Health Care for Women International', edited by Professor Emeritus Eleanor Krassen Covan of the University of North Carolina, Wilmington-USA.

Prior to this conference award, Dr. Mrs. Oduro had won a \$4,500 Fellowship grant from the African Doctoral Dissertation Research Fellowship (ADDRF) Programme, an initiative of the APHRC, Ford Foundation and the International Development Research Centre (IDRC-Canada) for her doctoral research which focused on: "Gender Relations, Sexuality and HIV/AIDS Education from a Youth Perspective".

## *Former UCC Student Awarded for Creation of Index-based Insurance for Farmers*



*Adolph Okine, former student of UCC and currently a Ph.D. Student in Actuarial Science, Risk Management, and Insurance at University of Wisconsin School of Business*



**A** first year Ph.D. student at the University of Wisconsin School of Business, received the Best Paper Award from the Journal of Insurance Issues, for his creation of an index-based insurance formula to provide stability to farmers in developing countries.

**Adolph Okine's** formula provides a way to insure farmers whose farms face unpredictable weather patterns.

Originally from Ghana, Okine earned his Bachelor's degree in Actuarial Science at University of Cape Coast. He then completed his Masters at Illinois State University before joining UW's Ph.D. programme.

*Prof. Samuel Yeboah Mensah from UCC honoured with the Academic Leadership Award by the National Society of Black Engineers, USA*



Prof. Samuel Yeboah Mensah has been awarded by the National Society of Black Engineers (NSBE), USA, for his massive contributions to science especially in the area of engineering at the 39th Annual Convention held in Indiana.

Prof. Mensah, a specialist in Nanotechnology is the first African to be honoured with the Academic Leadership award since its inception 39 years ago.

*UCC Alumnus Crowned Best Journalist of the Year*



An Alumnus of the University of Cape Coast, Mr. Seth Kwame Boateng has been adjudged the 2014 GJA/Prof. PAV Ansah Journalist of the Year at the annual awards ceremony held at the Banquet Hall in Accra last Saturday. Apart from being crowned the Journalist of the Year, Mr. Boateng also won three additional awards in features on radio and television at the function.

A plaque presented to Mr. Boateng commended him for “thorough research and enviable consistency on the job.”

Thirty-one year old Seth Kwame Boateng read Economics and Sociology at the University of Cape Coast for his bachelor’s degree from 2003-2007. At UCC, Mr. Boateng had opportunity to work at the then Radio Valco and rose to become the Head of News.





## *Prof. Frederick Ato Armah Appointed to the UNEP Global Panel of Experts on the Environment*



Prof. Frederick Ato Armah, Head of the Department of Environmental Science, School of Biological Sciences, and Deputy Director of the Directorate of Research, Innovation and Consultancy, University of Cape Coast, has been appointed by the United Nations Environment Programme (UNEP) to serve on its Global Panel of Experts on the Environment. Prof. Frederick Ato Armah is the only scientist from Ghana among the team of experts drawn from over 110 countries by the UNEP chief scientist. The appointment is for a period of two years (2015-2017).

The mandate of the Global Panel of Experts is to develop the 6th edition of the Global Environment Outlook (GEO-6) report. The theme for GEO-6 is Healthy Planet Healthy People. The Global Environment Outlook (GEO) is a consultative and participatory process that builds capacity for conducting integrated environmental assessments and reporting on the state, trends and outlooks of the environment. GEO is also a series of products that informs environmental decision-making and aims to facilitate the interaction between science and policy. According United Nations Environment Programme (UNEP), GEO-6 will be the start of a living process. It will provide the **first integrative baseline in light of global megatrends** supported by open access to data, with due consideration given to gender, indigenous knowledge, and cultural dimensions. The assessment will lay the foundation for continued socio-environmental assessments across relevant scales, with a thematic as well as an integrated focus, enabling and informing societal transitions and the tracking of SDG targets and goals as well as previously agreed internationally environmental goals.

The rigorous assessment process aims to make GEO products scientifically credible and policy relevant - providing information to support environmental management and policy development. Using the integrated environmental assessment (IEA) methodology, UNEP has produced four GEO reports thus far, which have analysed environmental state and trends at the global and regional scales, described plausible outlooks for various time frames and formulated policy options.

<http://www.unep.org/geo/>

[http://www.unep.org/geo/pdfs/geo6/GEO-6\\_ExpertsList.pdf](http://www.unep.org/geo/pdfs/geo6/GEO-6_ExpertsList.pdf)

## *Prof. Frederick Ato Armah Receives OUTSTANDING RESEARCHER Award*



Prof. Frederick Ato Armah has also been awarded the outstanding researcher award for 2015/2016 academic year at the University of Cape Coast reward and recognition ceremony. The citation reads “This award is presented to Prof. Frederick Ato Armah—your hard work, dexterity and great dedication have resulted in this great accomplishment. Ayekoo!!!”

Prof. Frederick Ato Armah has taught at every level of the educational ladder in Ghana (basic, secondary and tertiary). Cumulatively, Frederick has garnered over twenty years of teaching and research experience, eight of which is at the tertiary level. He has held several prestigious scholarships including the Swedish Institute Scholarship (2006-2008), Netherlands Fellowship (2009) and the Ontario Trillium Scholarship (2011-2015). Prof. Frederick Ato Armah has an excellent track record on scholarly potential and acquisition of research funds/grants and has served as consultant to several organisations and government agencies both local and international. He has extensive experience in teaching, research and collaboration with partners in both developed (Canada, Sweden, Netherlands, USA) and developing countries (Ethiopia, Cameroon, Ghana, Sierra Leone, Cambodia, Tanzania).

Frederick has also received the Council for Scientific and Industrial Research (CSIR) Science, Innovation and Technology joint award for the best innovative scientist in developing a technique for the removal of fluoride ions in Bongo using local available materials. This award was established to mark the Golden Jubilee of the CSIR in 2009. Following this award, Frederick was briefly part of a team of scientists that was developing technologies to produce safe drinking water using laterite, a soil-type, rich in iron and aluminium, as a sorbent and ultra-filtration for physical disinfection. This

initiative was collaboration between researchers at the Kwame Nkrumah University of Science & Technology (KNUST) in Ghana, and the University of Edinburgh, Scotland titled, “Safe Drinking Water using Appropriate Technologies for Ghana (SADWAT-GHANA)”.

Prof. Armah has over 100 peer-reviewed publications in international journals. Some of his scholarly works have appeared in high impact factor journals such as PLOS one, Environmental Health Perspectives, Environment International, Environmental Research, Frontiers in Environmental Science, EcoHealth, Toxicological and Environmental Chemistry, Environmental Science and Pollution Research, GeoJournal and Mitigation and Adaptation Strategies for Global Change.

Frederick is currently an Associate Editor of the Groundwater Resources and Management Specialty Section of the Frontiers in Environmental Science Journal, which is based in Switzerland. Prof. Armah is also a regular reviewer for several international journals published by Elsevier, Taylor & Francis, Springer, and Mary Ann Liebert. Prof. Armah has also served as External Reviewer for the Human and Institutional Capacity Development Directorate of the National Research Foundation (NRF) of the South Africa Thuthuka Programme. He is an External Examiner for the Master of Science programme in Environmental Science at Rhodes University, Grahamstown, South Africa. He has also served as a reviewer of proposals on the “Energy - Health - Natural Disasters” nexus in African cities programme initiated by the International Council for Science (ICSU), in partnership with the Network of African Science Academies (NASAC) and the International Social Science Council (ISSC).

Prof. Armah is a member of several professional organisations including the International Association of Hydrological Sciences, International Society for Environmental Information Sciences, Earth Systems Governance, and the Institute for Research on Environment and Sustainability. He is also member of various communities of practice including the Climate Change and Forestry Adaptation Communities of Practice: Ontario Centre for Climate Impacts and Adaptation Resources (OCCIAR), Canada and Too Big to Ignore (TBTI): Global Response Cluster of the Integrated Marine Biogeochemistry and Ecosystem Research (IMBER). He has given numerous guest lectures at high ranking universities across the globe including the University of Dar es Salaam, Tanzania; University of Toledo, Ohio, USA and Pennsylvania State University, USA.

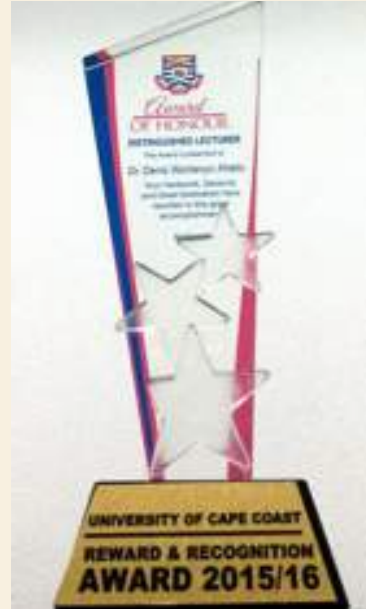

### *Distinguished Lecturer Award*



The Director of the Centre for Coastal Management (CCM) and Associate Professor at the Department of Fisheries and Aquatic Sciences, Prof. Denis W. Aheto, has received the University of Cape Coast award of honour as Distinguished Lecturer for the 2015/16 academic year. Prof. Denis Worlanyo Aheto has a broad academic training and international exposure. He has participated in interdisciplinary researches in his home country, Ghana and elsewhere notably Sweden, Thailand, Namibia, Zambia, and South Africa and presented papers at meetings or conferences in Nigeria, Kenya, Uganda, Tanzania, Japan and Germany and has attended professional training programmes in the United States of America. He holds a PhD in Environmental Sciences (2008) from

the University of Bremen (Germany) and two Masters Degrees in Rural Development Studies (2002) and Tropical Aquatic Ecology (2004) obtained from the Swedish Agricultural University (Sweden) and University of Bremen (Germany) respectively. He holds a Bachelor's Degree in Biological Sciences and a Diploma in Education from the University of Cape Coast (1998). He was a Teaching and Research Assistant following his graduation in 1998/99.

He teaches eight (8) courses at UCC with the changing academic semesters and supervises several PhD and MPhil students, as well as undergraduate students. He is Project Manager and UCC's authorized representative of a five-year fisheries and coastal management capacity development project (2014-2019) worth US\$ 5.5 million funded by United States Agency for International Development (USAID) under the Feed the Future Initiative of the American Government. He also doubles as the Coordinator of an innovative public-private partnership project that is collaborating with Ainoo-Ansah farms, a private aquaculture company in Ghana to establish an Aquaculture Training Centre of Excellence funded by the Government of Ghana, DANIDA and the World Bank through the Skills Development Fund of the Council for Technical and Vocational Education & Training (COTVET).

Prof. Aheto has served and continues to contribute as Chairman and member of some university-wide Boards and Committees. He has a book published, book chapters and over 30 scientific articles and technical reports to his credit. He is a member of the UNESCO Man and the Biosphere (MAB) National Committee under the auspices of the Environmental Protection Agency (EPA) of Ghana.



### *Mr. & Mrs. Abnory Adjudged Outstanding Presenters at an International Conference*



**M**r. Moses M. Abnory and Mrs. Sophia Abnory were adjudged the most outstanding presenters at the International Journal of Arts and Sciences Conference in Toronto, Canada. They received a certificate each for their remarkable delivery at the conference. At the conference, they jointly presented a paper on the topic “Comparative Analysis of Emotional Intelligence of Private and Public Universities in Ghana”, which was considered as the best presentation at the conference.

### *Prof. Peter Kwapong Wins British Council Award*



**P**rof. Peter Kofi Kwapong has been honoured by the British Council as the Most Effective Ambassador 2012. At British Council Alumni Reception held in Accra, Prof. Kwapong was honoured for being the most innovative alumnus of all the British trained scholars. Prof. Kwapong had as his prize a plaque and a Dell Inspiron Notebook computer. He was also awarded with the UCC@50 Award for being the most Innovative Individual.

### *UCC Wins Erasmus Mundus Grant for Staff and Students Mobility*



**T**he University of Cape Coast through the Centre for International Education has won an award for the Erasmus Mundus Grant for Staff and Students Mobility with the Copenhagen Business Academy, Denmark.

Erasmus Mundus is a cooperation and mobility programme in the field of higher education that aims to enhance the quality of European higher education and to promote dialogue and understanding between people and cultures through cooperation with third-world countries. In addition, it contributes to the development of human resources and the international cooperation capacity of Higher education institutions in third-world countries by increasing mobility between the European Union and these countries.

## Two DUHS Staff Members Receive Medical Excellence Awards



Two members of staff of the Directorate of University Health Services (DUHS) have been awarded at the 2nd National Medical Excellence Awards for their outstanding achievements in the field of healthcare delivery. The award ceremony, held at the Banquet Hall of the State House, Accra, was aimed at boosting the confidence and morale of professionals in the health sector.

The Medical Excellence Awards (MEA) for Healthcare Delivery Personnel was established in 2011 with the objective of honouring health care delivery works both in public and private sector.

The two awardees - Mrs. Gloria Baaba Aubyn, Principal Laboratory Technician of DUHS, and Dr. Patrick Akwasi Baah, a Dental Surgeon and the Deputy Director of DUHS - were presented with citations.

## Dr.-Ing. Samuel Kofi Tulashie Wins 2016 Most Published Author in Engineering



A senior lecturer at the Department of Chemistry, University of Cape Coast, Dr.-Ing. Samuel Kofi Tulashie has been awarded as the 2016 Most Published Author in the field of engineering by the Ghana Institution of Engineers (GhIE).

“Engineering and Innovations to Promote National Development”. Dr.-Ing. Tulashie’s publication in Research Safety won him the award in the Advancing Engineering Knowledge Category which he competed with another professor.

The award was conferred on him recently at the 3rd Engineering Excellence Award held in Accra. The ceremony was on the theme

# DIRECTORATE OF RESEARCH, INNOVATION AND CONSULTANCY (DRIC)

## About Us

The Directorate of Research, Innovation and Consultancy (DRIC) was established in August 2013 following the promulgation of a research agenda for the University of Cape Coast for the period 2012 - 2017. The DRIC is a registered member of Ghana Association of Consultants (GAC. 0182).

## Mission

To oversee Consultancy Services engaged in by individuals and groups in the University; implement the University's research agenda; and create conducive environment to nurture creativity and innovation.

## Vision

"To have a Research, Innovation and Consultancy Directorate that is strongly positioned, with a world-wide acclaim"

## Our Mandate

The mandate of DRIC is to oversee Consultancy Services engaged in by individuals and groups in the University; oversee and support the conduct of research in the University and create a conducive environment to nurture creativity and innovation.

In order to fully realise this mandate, DRIC performs the following functions:

1. Develop, review, sensitise and implement tenets of University Research, Innovation and Consultancy Policies.
2. Develop and coordinate university-wide research agenda.
3. Source funding for research and manage all designated research funds.
4. Develop and routinely advise the Academic Board on the (i) criteria for the research component for promotion; (ii) motivating research effort of faculty; and (iii) sponsoring research and conferences.
5. Organise and support Departments in the collection of longitudinal data and generate a repository of secondary data by liaising with relevant agencies that collect data.
6. Coordinate all seminars and workshops in the University based

on the research agenda.

7. Coordinate and support the publication of journals and books in the University.
8. Liaise with the Directorate of Academic Planning and Quality Assurance (DAPQA) to advise the University management on procedures that promote research-based teaching, and report all activities annually to the Academic Board through the Vice Chancellor.
9. Undertake Consultancy (Research Training & Advisory Services) in the areas of Education, Agriculture, Tourism, Science, Socio-Economic Development, Industry, Business and the Environment.
10. Provide a wide range of expert and professional services for the local environment and the nation.
11. Act as a clearinghouse for all individual and group consultancies in the University.
12. Identify, promote and facilitate innovations and patenting

## Strengths

The following are the strengths of DRIC:

- Unique advantage of drawing on a wide range of expertise available in all Faculties, Departments, Units and Sections of the University;
- Possess a portfolio of research and consultancy experience;
- Mandated to image the research and innovation activities of the University;
- External recognition as the outfit authorised to facilitate the conduct of research, innovation and consultancy in the University;
- Mandated to use all available physical facilities, equipment and support services in the Faculties, Research Centres and Institutes of the University in the execution of consultancy projects.



## *Experience and Expertise*

The Directorate has vast experience with both local and international donor-funded projects in research and training programmes. Some of our clients include the following:

- USAID through ADVANCE II and METTS PBS Projects
- Plan International, Ghana
- Ministry of Finance and Economic Planning through the RAFP project
- International Labour Organisation USAID through Background studies on Ghana's Agriculture and Infrastructure Project
- USAID through the Danish Development Agency (DANIDA)
- United Nations Development Programme (UNDP)
- German Technical Corporation (GTZ)
- Kofi Annan International Peacekeeping Training Centre (KAIPTC)
- Ministry of Local Government and Rural Development, through the Local Government Service Secretariat (LGSS) and the Metropolitan Municipal and District Assemblies (MMDAs).
- Ministry of Women and Children Affairs, through the Gender Responsive Skills and Community Development Project
- Ministry of Local Government and Rural Development.
- Allan Guttmacher Institute, U.S.A.
- United Nations Fund for Population Activities UNFPA (Ghana Office)
- Brown University, U.S.A.
- Centre for Development and Population Washington DC, USA
- Department for International Development (DFID)
- Economic and Social Research Council/Department for International Development (ESRC/DFID) UK
- National Investment Bank (NIB), Ghana
- The French Embassy, Accra.
- World Bank/Rural Financial Services Project of Bank of Ghana

## *HIGHLIGHTS OF THE MAJOR ACTIVITIES OR DEVELOPMENTS FOR THE LAST QUARTER OF 2016 TO AUGUST, 2017*

### *Expressions of Interest:*

The Directorate expressed interest in the following consultancy projects:

- Consulting Services for Citizens Perception survey at the end of project of the Ministry of Local Government and Rural Development
- Consulting Services for Beneficiary assessment Project of Ministry of Local Government and Rural Development

- Implementation of Cassava Integrated Enterprise Development Project for Export Trade, Agricultural & Industrial Development Fund (EDAIF) under Ministry of Trade and Industry.
- Implementation of Graduate Enterprise Development Initiative (GEDI) Project for Export Trade, Agricultural & Industrial Development Fund (EDAIF) under Ministry of Trade and Industry.
- USAID-Health Policy Plus: Request for Letter of interest for Proposal for Measuring HIV-Related Stigma in Healthcare Facilities.
- Consultancy Service for the Development of Training Modules in Various Courses Related to SME's on Starting and Growing a Business for Ghana Institutional Support Project/Ministry of Finance.
- "Skills development, job readiness program; and institutional support to ministry of youth and sports."- Ministry of Youth and Sports, Monrovia Liberia
- Consultancy Service for Delivery of Training Communication and Technical Report Writing Skills
- "Entrepreneurship development (business incubation and growth)." - Ministry of Youth and Sports, Monrovia Liberia

## *Technical and Financial Proposals*

The following technical proposals were submitted within the period under consideration:

- Baseline Survey of Rural Emergency Health Services Transport (REST) II Project of the Catholic Relief Services
- Catholic Relief Services Baseline Survey of ICOWASH Project
- Financing Ghanaian Agricultural Project (FinGAP) - USAID/METSS
- Background studies on employment in the infrastructure sector with a focus on Public Investments (PI) and employment in Ghana for the International Labour Organization (ILO).
- Consulting services for Background Studies on employment in the Agricultural and Agro-Processing sectors in Ghana for the ILO Strengthen Project
- Functional and Organisational Assessment of 38 MMDAs in Zone 2 (BAR, UWR) - Ministry of Local Government and Rural Development
- Production and Utilisation of Under-Utilised Solanaceae Vegetables for Nutritional Security in Ghana - Federal Office for Agriculture and Food (BLE), Germany
- Technical Support for the Collection and Analysis of Most Significant Change (MSC) Stories at Regional and District and Sub-District Level - UNICEP

- Technical Support for the collection and analysis of Most Significant Change (MSC) stories at regional and District and sub-district level-UNICEF Ghana Office
  - Functional and Organisational Assessment of 38 MMDAs in Zone 2 (BAR, UWR) - Ministry of Local Government and Rural Development
  - Qualitative Data Collection Agency-Rural Sanitation Operational Research, Oxford Policy Management
  - Mobile Laboratory
  - Strategic Partnerships for Higher Education Innovation and Reform (SPHEIR)
  - Improving Uptake and Adherence to HIV Prevention Strategies Among Adolescent Girls and Young Women in Ghana through a Multi-Level and Multiple Intervention Approach
  - Providing New Impetus and Solutions to Meet the Sustainable Development Goal 3 Targets for Maternal Neonatal and Child Health (MNCH) in Africa
  - Health Systems Research Initiative: Providing Evidence to Strengthen Health Systems in Low- and Middle-Income Countries (LMICs)
  - Developing a partnership to enhance rehabilitation services for people with sight impairment in Ghana-AHRC-MRC Global Public Health; Partnership Call for Applications
7. Workshop on Emotional Intelligence for the Senior Staff of Ghana Rubber Estates Limited, Takoradi, from Tuesday, 13th December, to Friday, 16th December, 2016.
  8. Consultancy Services for the Complimentary Basic Education (CBE) Learners Assessment Project for the United Kingdom Department for International Development (DFID) - Final end-line survey report submitted.
  9. Consultancy Services for the Implementation Partner for Graduate Enterprise Development Initiative (GEDI) for the Export Trade, Agricultural and Industrial Development Fund (EDAIF) - First phase out of three is completed.
  10. Consultancy Services for the Implementation Partner for Graduate Enterprise Development Initiative (GEDI) for the Export Trade, Agricultural and Industrial Development Fund (EDAIF) - Second phase out of three has begun.
  11. Financing Ghanaian Agricultural Project (FinGAP) - USAID/METSS
  12. Consulting Services for Background Studies for the ILO "Strengthen" Project
  13. The Council for Technical and Vocational Education and Training (COTVET) Glassblowing Project at the University of Cape Coast: This collaborative project between DRIC and the Department of Chemistry is currently at the final implementation stage.

### **Research and Consultancy Projects [Completed/ On-going]**

The following are on-going projects in the period under review:

1. USAID ADVANCE II Project dubbed 'Selected Knowledge Management and Learning Topics'-Ongoing
2. Plan International, Ghana's Green Skills for Ghana Project-Completed
3. Background studies on employment in the infrastructure sector with a focus on Public Investments (PI) and employment in Ghana for the International Labour Organization (ILO):-Completed
4. Consulting services for Background Studies on employment in the Agricultural and Agro-Processing sectors in Ghana for the ILO Strengthen Project-Completed
5. The Council for Technical and Vocational Education and Training (COTVET) Glassblowing Project at the University of Cape Coast: This collaborative project between DRIC and the Department of Chemistry-Completed
6. In collaboration with NADMO and UNDP, the Directorate, organised training workshops from 17th October to 18th November, 2016 targeted at Mainstreaming Disaster Risk Reduction for Practitioners in Ghana.

### **Research Awards and Grants**

The Second Call for Applications for Research Awards (BRA) and the Call for Proposals for Research Support Grants (RSG) were rolled out. A total amount of Five Hundred Thousand Ghana Cedis (GH¢500,000.00) was committed to the Research Support Grant (RSG) and Awards for the 2016-17 Academic Year.

#### **1. Research Support Grants**

The 2016-2017 Call was structured in three (3) parts with the following details:

- a. *Individual/Group RSG* - GHC5,000 for CHLS, CoDE and CES and GHC7,000 for CANS and CoHAS
- b. *Inter-Departmental RSG* - GHC30,000
- c. *Policy and Practice-Oriented (University-Wide) RSG* - GHC50,000

#### **2. Best Researcher Awards**

There were three (3) research awards on offer and the details and criteria were as follows:

- a. *Best Evolving Researcher Award (BERA)*

Beneficiary of BERA were to receive a citation and financial award of GHC5,000.00

*b. Best Evolved Researcher Award (BEEdRA) -- 1st& 2nd Positions*

Beneficiaries of BEEdRA were to receive a citation and financial award of GHC10,000.00 and GHC8,000.00 for 1st and 2nd positions, respectively.

*c. Best College-Level Researcher Award for Publications and Citations (BCLRA)*

There was one award for each College (A citation and financial award GHC1,500.00 per College)

## **CORE RESEARCH STAFF**



**DR. JUSTICE MENSAH**

Research Fellow  
jmensah@ucc.edu.gh



**DR. SAMUEL ASIEDU OWUSU**

Research Fellow  
sowusu@ucc.edu.gh



**MR. ISAAC NKETSI AH**

Principal Research Assistant  
isaac.nketsiah@ucc.edu.gh

## **CORE ADMINISTRATIVE STAFF**



**MRS. MILLICENT A. ANING-AGYEI**

Junior Assistant Registrar  
maning-agyei@ucc.edu.gh



**MR. MATTHEW QUAIDOO**

Principal Administrative Assistant  
matthew.quaidoo@ucc.edu.gh



**MR. ANDREW NKETSI AH-ESSUON**

Assistant Accountant  
a.nketsiahessuon@ucc.edu.gh

## DRIC Management Committee Members



Prof. George K. T. Oduro

### Pro-Vice Chancellor (Chairperson)

1.	Prof. Livingstone K. Sam-Amoah	Provost, College of Agric. & Natural Sciences	<b>Member</b>
2.	Prof. Isaac K. Galyuon	Provost, College of Distance Education	<b>Member</b>
3.	Prof. Eric M. Wilmot	Provost, College of Education Studies	<b>Member</b>
4.	Prof. Dora F. Edu-Buandoh	Provost, College of Humanities & Legal Studies	<b>Member</b>
5.	Prof. Johnson N. Boampong	Provost, College of Health & Allied Sciences	<b>Member</b>
6.	Prof. Ernest L. Okorley	Dean, School of Graduate Studies	<b>Member</b>
7.	Prof. David K. Essumang	Dean, School of Physical Sciences	<b>Member</b>
8.	Prof. Elvis Asare-Bediako	Dean, School of Agriculture	<b>Member</b>
9.	Prof. Justice K. Sarfo	Dean, School of Biological Sciences	<b>Member</b>
10.	Prof. Tsivanyoh K. Yiboe	Dean, Fac. of Humanities & Soc. Sciences Educ.	<b>Member</b>
11.	Prof. Joseph K. Mintah	Dean, Faculty of Sci. & Technology Education	<b>Member</b>
12.	Prof. Eric Nyarko-Sampson	Dean, Faculty of Educational Foundations	<b>Member</b>
13.	Prof. Ernest K. Davis	Dean, Sch. of Educational Dev. & Outreach	<b>Member</b>
14.	Prof. Francis E. Amuquandoh	Dean, Faculty of Social Sciences	<b>Member</b>
15.	Prof. Edward Marfo-Yiadom	Dean, School of Business	<b>Member</b>
16.	Prof. Joseph B. A. Aful	Dean, Faculty of Arts	<b>Member</b>
17.	Dr. Elias K. McDave	Dean, Faculty of Law	<b>Member</b>
18.	Prof. Moses J. Eghan	Dean, School of Allied Health Sciences	<b>Member</b>
19.	Prof. Francis. W. Ofei	Dean, School of Medical Sciences	<b>Member</b>
20.	Prof. Alexander N. M. Pappoe	Dean, School of Nursing	<b>Member</b>
21.	Prof. Samuel K. Annim	Director, DRIC	<b>Member</b>
22.	Prof. Frederick A. Armah	Deputy Director, DRIC	<b>Member</b>
23.	Mr. Francis Obeng	Representative, Directorate of Finance	<b>Member</b>
24.	Dr. MacAnthony Cobblah	Librarian, Sam Jonah Library	<b>Co-opted Member</b>
25.	Mrs. Millicent A. Aning-Agyei	Junior Assistant Registrar, DRIC	<b>Secretary</b>



## ACKNOWLEDGEMENTS

### Co-Chairs:

Prof. Samuel Kobina Annim	Director, DRIC
Prof. Frederick Ato Armah	Deputy Director, DRIC

### Research Report Coordinating Team Members:

1. Dr. Simon Mariwah	Faculty of Social Sciences
2. Dr. Samuel Agblorti	Faculty of Social Sciences
3. Dr. Florian Carl	Faculty of Arts
4. Dr. Kofi Ayebi-Arthur	Faculty of Science & Technology Education
5. Dr. Alfred Ampah-Mensah	Sch. of Educational Dev. & Outreach
6. Dr. Charles A. Oppong	Faculty of Humanities & Soc. Sci. Education
7. Dr. David O. Yawson	School of Agriculture
8. Dr. Julius K. Hagan	School of Agriculture
9. Dr. Baah Sefa-Ntiri	School of Physical Sciences
10. Prof. Victor Y. A. Barku	School of Physical Sciences
11. Prof. Denis W. Aheto	School of Biological Sciences
12. Dr. Enoch T. Quayson	School of Biological Sciences
13. Dr. Akwasi Anyaful	School of Medical Sciences
14. Ms. Anna Hayfron-Benjamin	School of Nursing
15. Dr. Precious A. Mattah	Directorate of Academic Planning & Quality Assurance
16. Mr. Alfred Ghartey	Centre for International Education
17. Dr. Justice Mensah	DRIC
18. Dr. Samuel A. Owusu	DRIC
19. Mrs. Millicent A. Aning-Agyei	DRIC
20. Mr. Matthew Quaidoo	DRIC
21. Mr. Isaac Nketsiah	DRIC

